

# ■ PROTECO®

**skleník oblúčkový 310 x 205 x 205 cm**

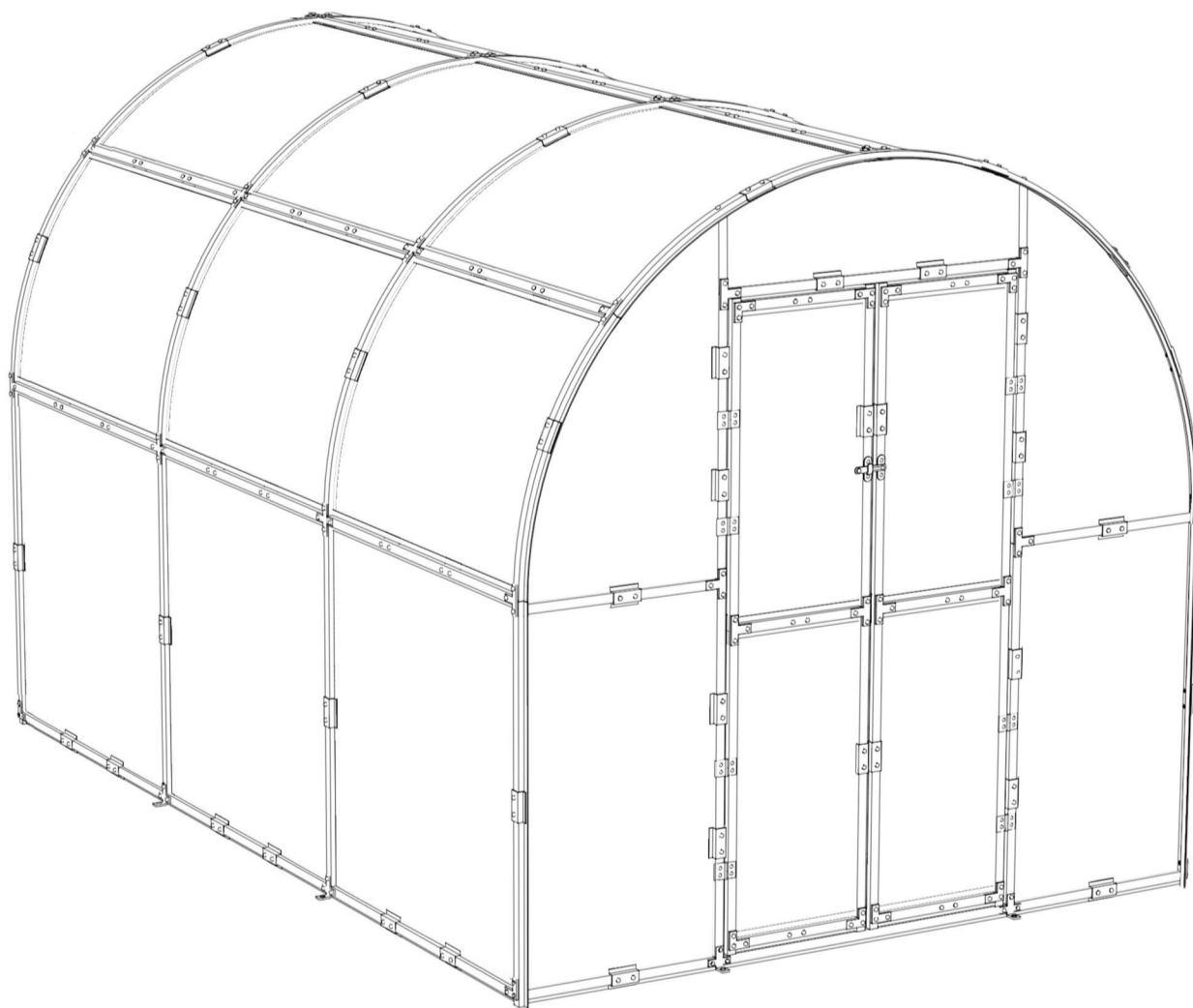

**SK**

# **Upozornenie**

**Pro správnu inštaláciu postupujte podľa týchto pokynov**

**1. Skleník skladajte v dvoch osobách. Doba inštalácie sa pohybuje medzi 4-5 hodinami.**

**2. Pri inštalácii používajte len ručné náradie. Na dotiahnutie skrutiek odporúčame na konci použiť elektrické náradie.**

**3. Skrutky dotiahnite až po vložení polykarbonátových dosiek do profilov. V opačnom prípade nebudete môcť dosky zasunúť do profilov.**

**4. Nezabudnite, že tento skleník nie je úplne vodotesný. To môže viesť k presakovaniu vody v prípade silných dažďov.**



## **Kotvenie**



**Skleník musí stáť na rovnom povrchu po obvode svojej základne a na podklade, ktorý udrží upevnenie základne skleníka. Základňa na ukotvenie skleníka musí byť vodorovne vyrobená z pevného stabilného materiálu (aby sa nemohli meniť jej vlastnosti, rozmery a deformácie).**

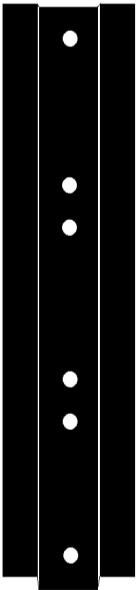
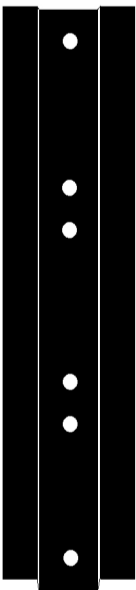
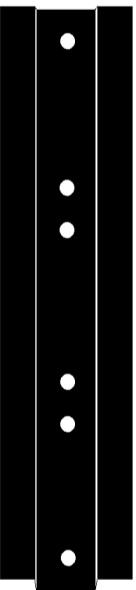
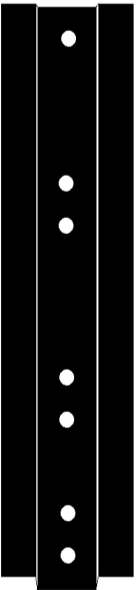
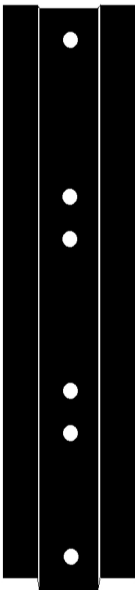
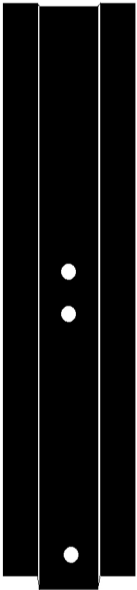
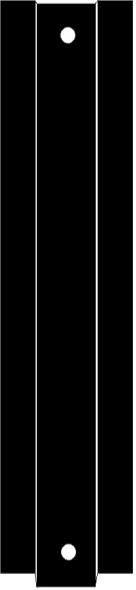
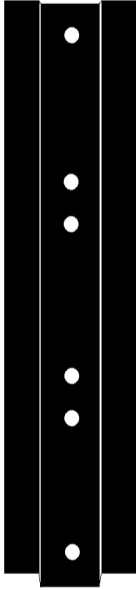
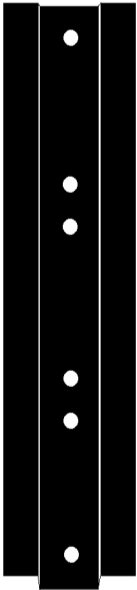
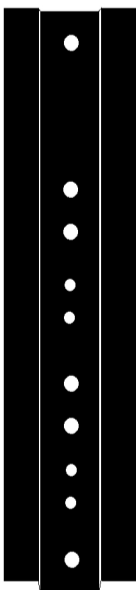
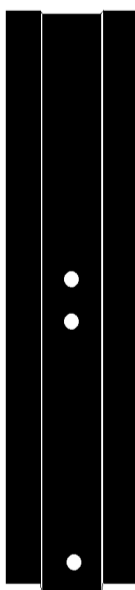
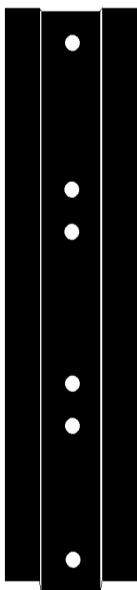

**Kotviace prvky (skrutky, kotvy) základne skleníka musia byť pevne upevnené v základni skleníka tak, aby sa skleník nemohol pohybovať, ale zároveň sa skleník nesmie deformovať, keď sa kotviace prvky utiahnu.**

**Základňa musí zabezpečovať stabilitu konštrukcie, musí byť vodorovná a mať všetky štyri strany navzájom kolmé. Ak máte čo i len najmenšie pochybnosti o tom, či základňa skleník udrží, a hrozí, že skleník nebude dostatočne ukotvený, vybetónujte pätky nosných oblúkov alebo skleník postavte na inom mieste. Dôrazne odporúčame, aby boli kotviace body zabetónované.**

**Poškodenie skleníka v dôsledku nedostatočného ukotvenia v zemi a nesprávnej montáže sa nepovažuje za výrobnú vadu a nie je možné ho reklamovať. Skleník musí byť vždy ukotvený, nesmie sa nechať voľne na zemi!!!**

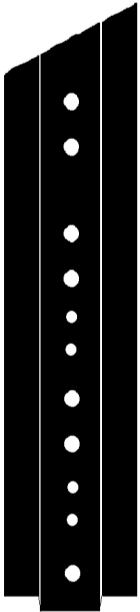
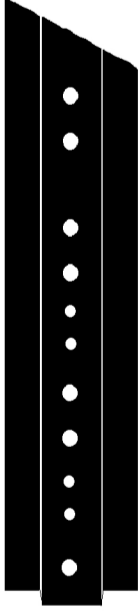
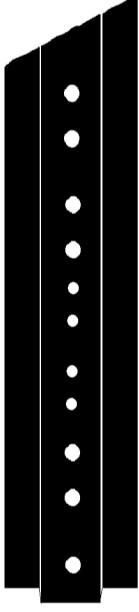
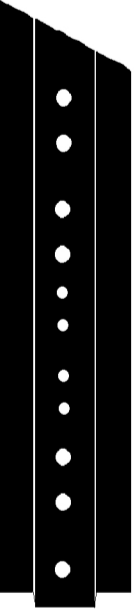
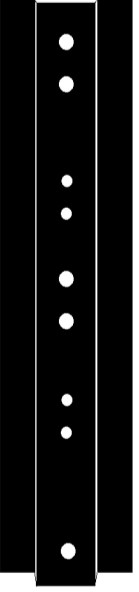
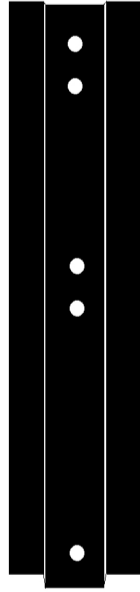
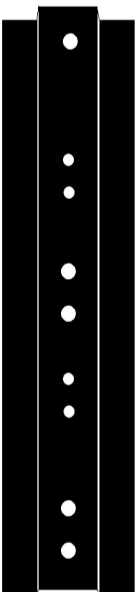
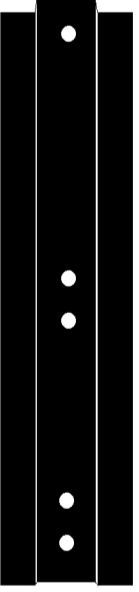
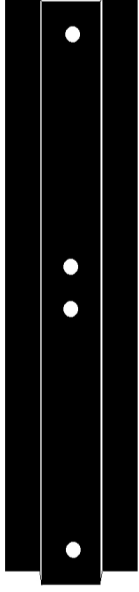
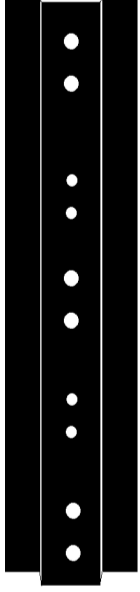
NO.1	NO.2	NO.3	NO.4	NO.5	NO.6
					
1020MM 4KS	1030MM 2KS	1010MM 15KS	1080MM 4KS	1050MM 4KS	515MM 4KS
NO.7	NO.8	NO.9	NO.9a	NO.10	NO.11
					
1000MM 1KS	1000MM 1KS	1030MM 2KS	1030MM 2KS	505MM 4KS	980MM 3KS

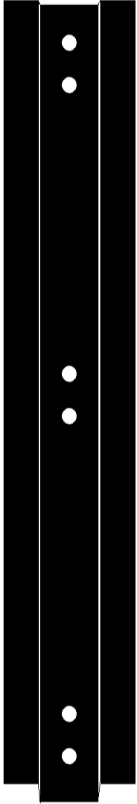
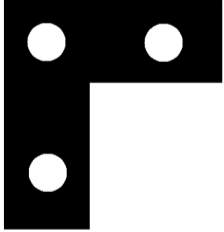
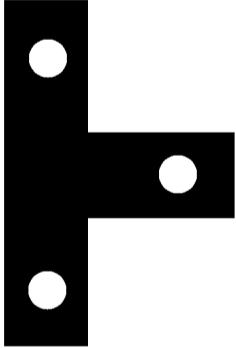
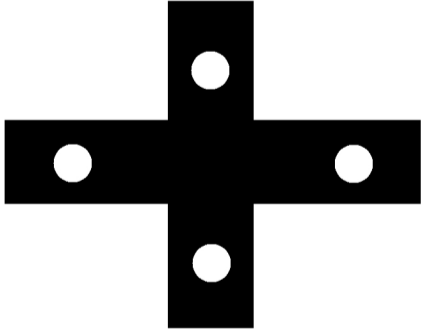
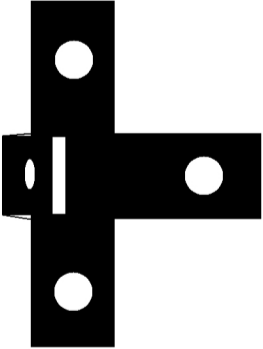
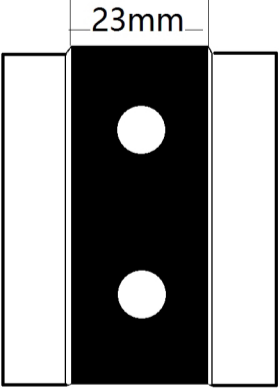
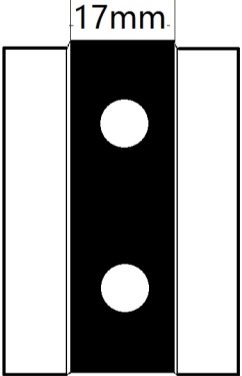
NO.12	NO.12a	NO.13	NO.14	NO.15	NO.16
					
785MM 12 KS	785MM 4KS	890MM 1KS	890MM 1KS	890MM 1KS	890MM 1KS
NO.17	NO.18	NO.19	NO.20	NO.21	NO.22
					
885MM 2KS	885MM 2KS	885MM 2KS	885MM 2KS	415MM 10KS	730MM 2KS

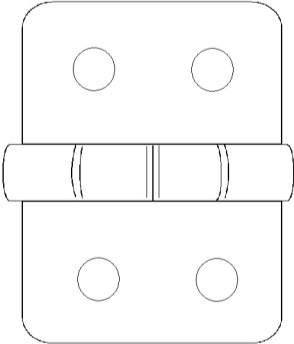
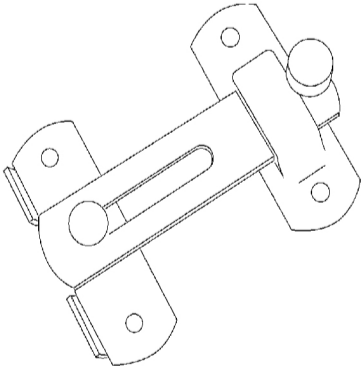
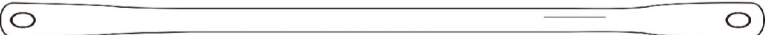
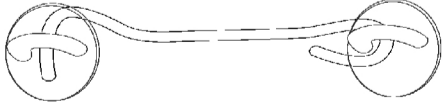
NO.23	A x20KS	B x20KS	C x12KS
 <p data-bbox="97 1160 256 1267">730MM 2KS</p>			
	D x8KS	E x88KS	F x76KS
		 <p data-bbox="810 913 906 947">23mm</p>	 <p data-bbox="1278 920 1374 954">17mm</p>
G x448KS	H x56KS	I x12KS	J x2KS
			
K x8KS		L x4KS	
			

**1035x1010mm**

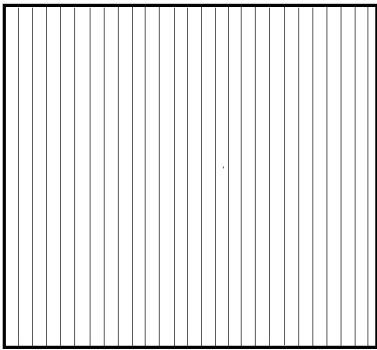

**X 6KS**

**410x840mm**

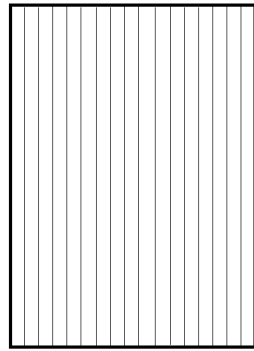

**X 4KS**

**765x1010mm**

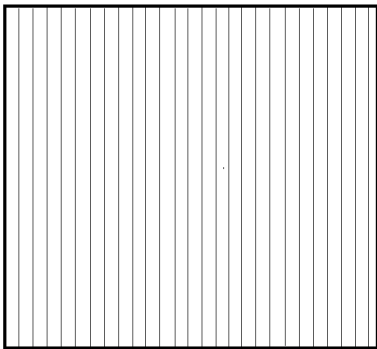

**X 12KS**

**410x660mm**

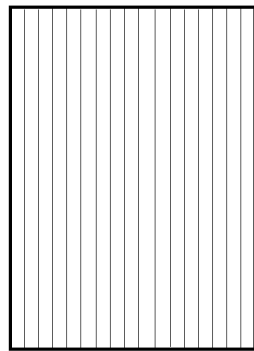

**X 2KS**

**505x1015mm**

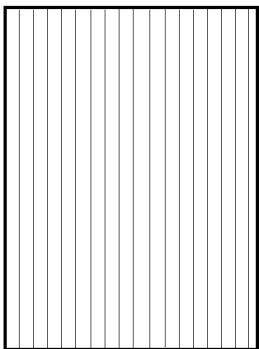

**X 4KS**

**505x870mm**

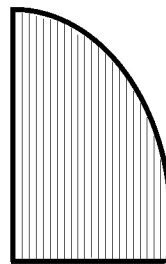

**X 2KS**

**505x870mm**

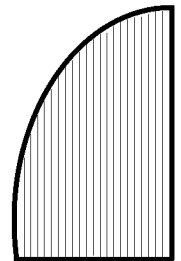

**X 2KS**

**980x1015mm**

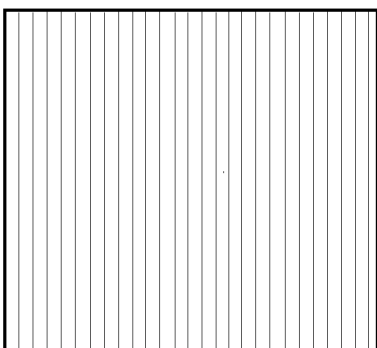



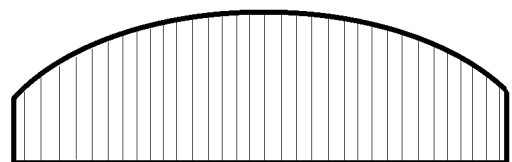

**X 1KS**

**980x240mm**

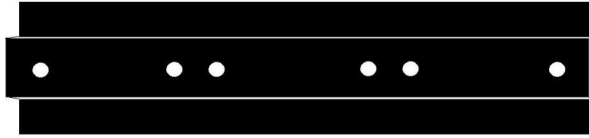
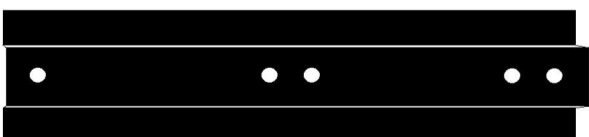

**X 2KS**

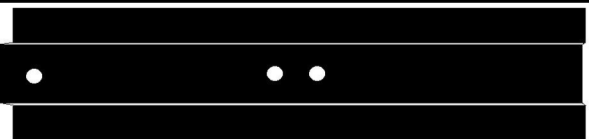
# KROK 1

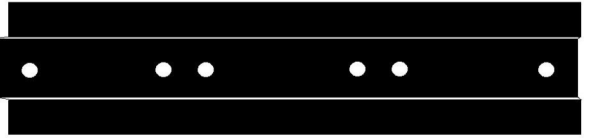
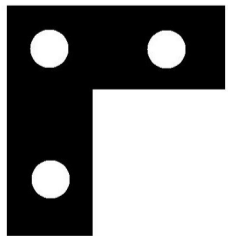
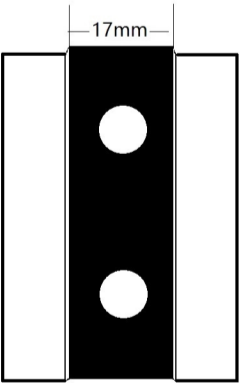
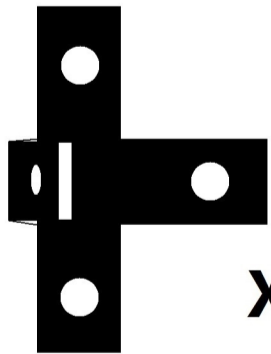
ČÍSLO DÍLU	OBRÁZOK		POČET
1			4
2			2
4		dole 	4
6			4
7			1
8			1
A		x4	
F		x8	D 

**Skrutky pred inštaláciou polykarbonátových panelov nedotahujte.**

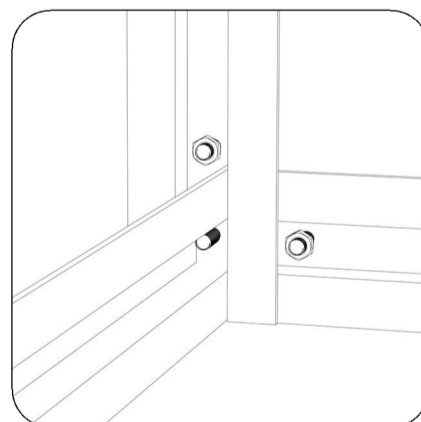
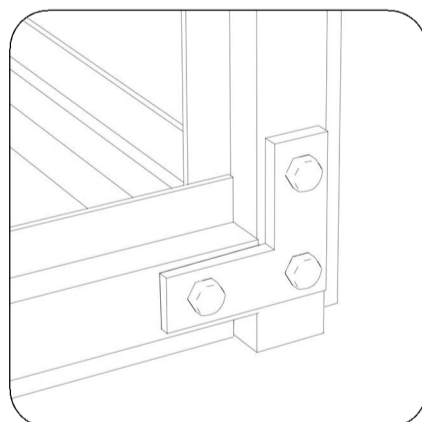
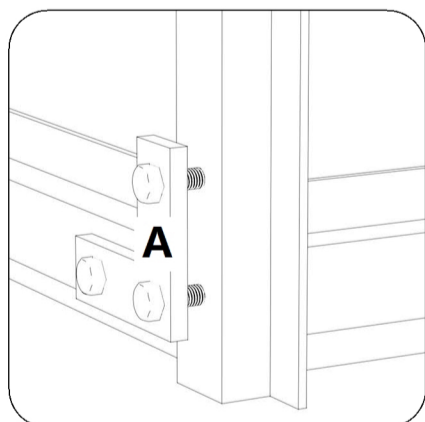
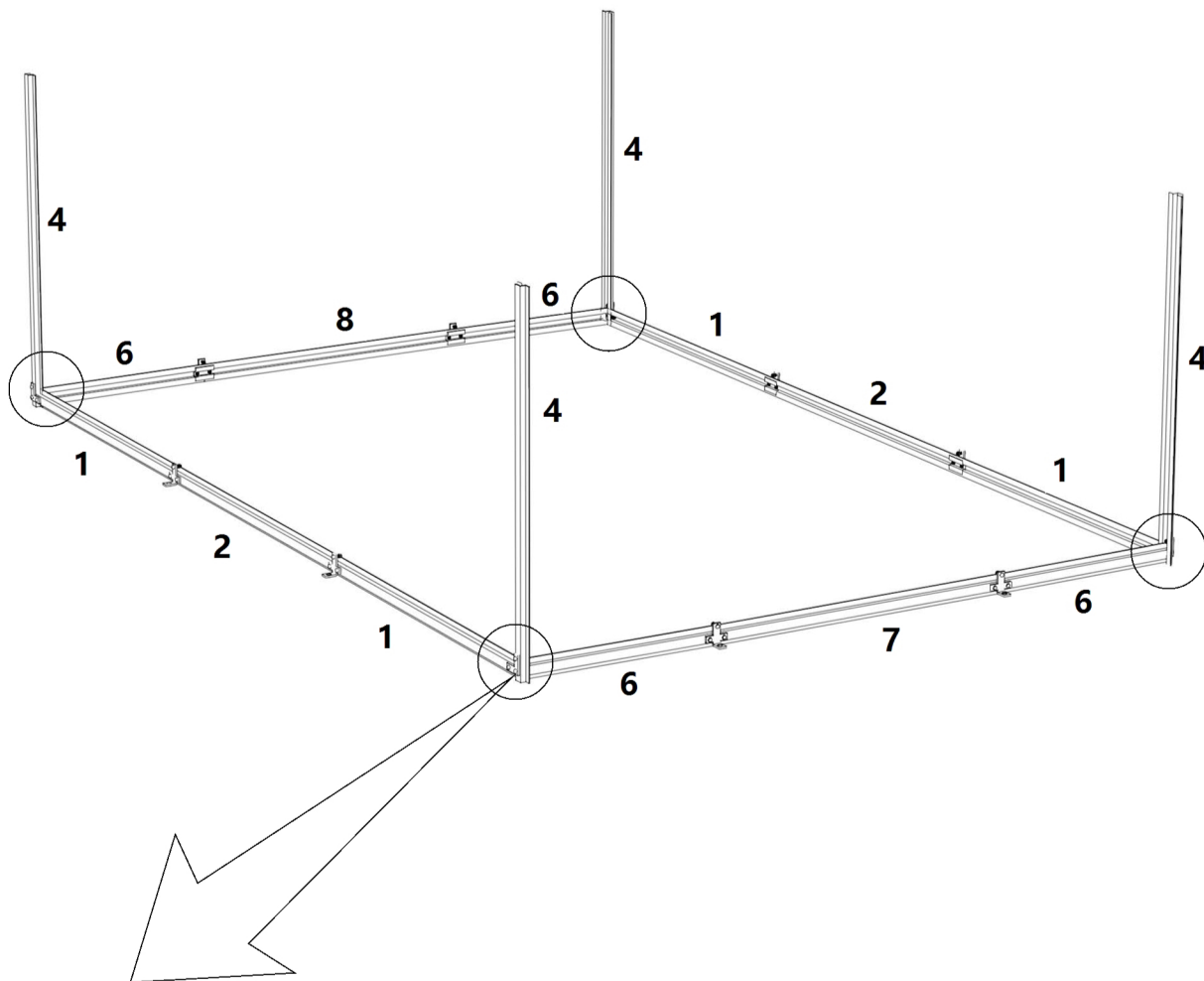

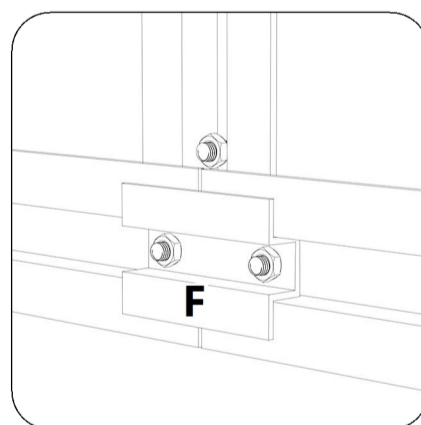
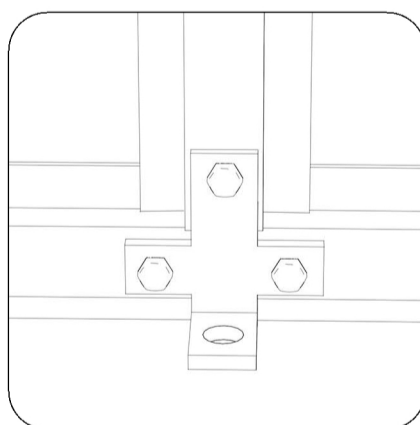
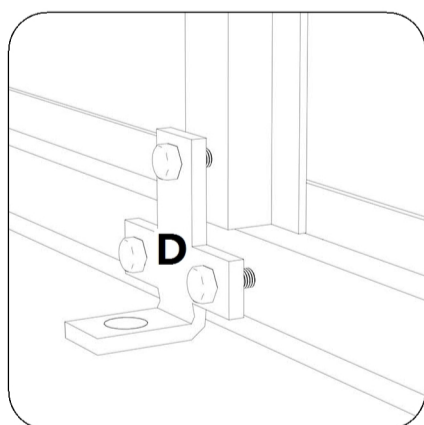
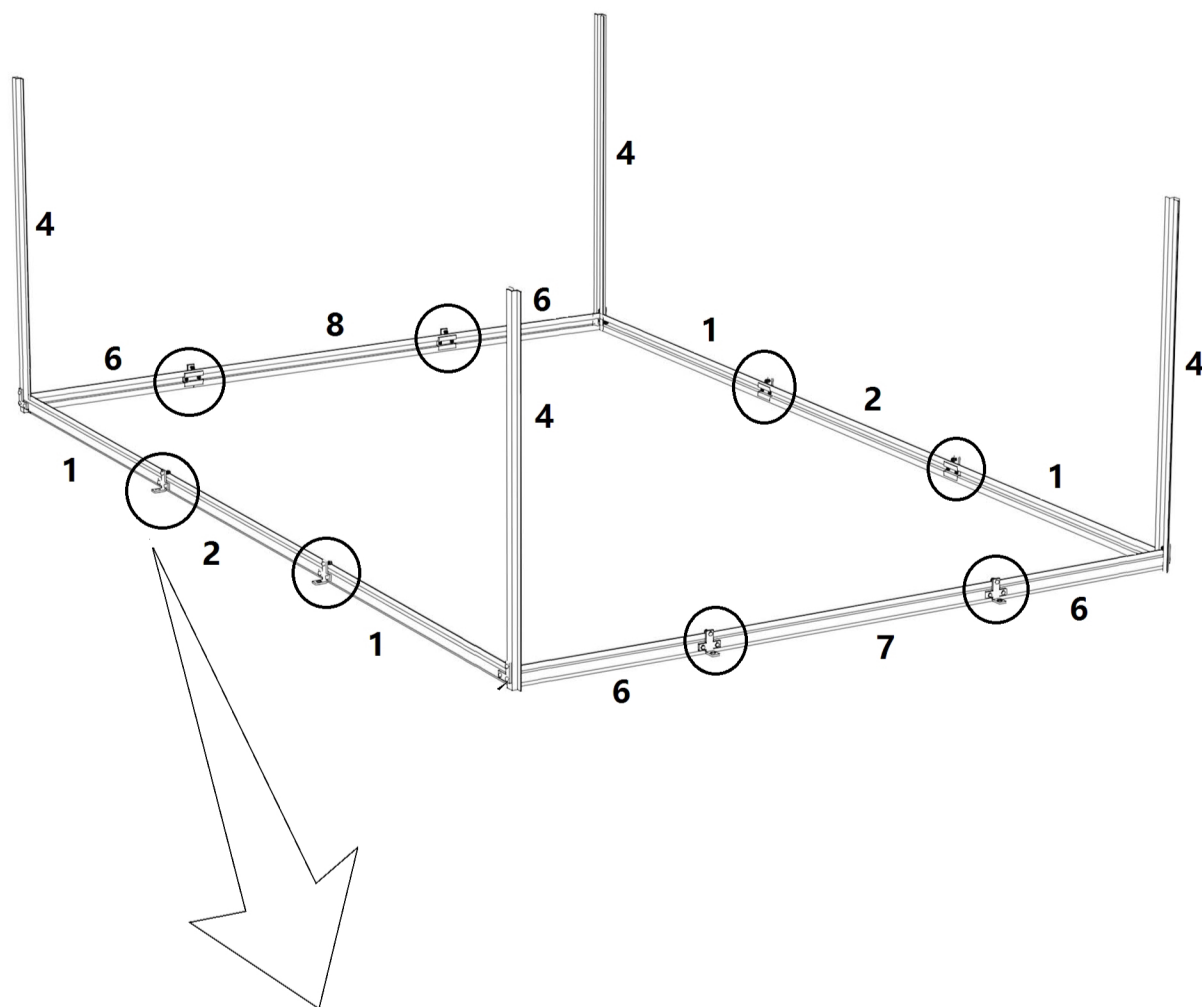

**Skrutky pred inštaláciou polykarbonátových panelov nedotahujte.**



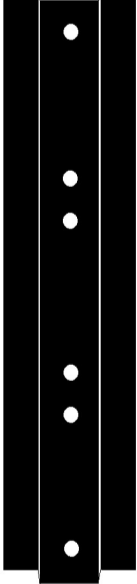
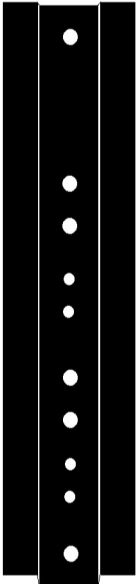
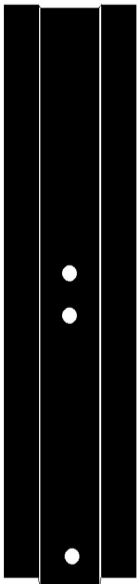
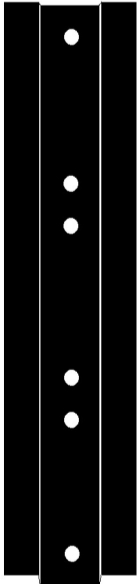

# KROK 2

ČÍSLO DÍLU	9	9A	10	11
OBRÁZOK				
POČET	2	2	4	3

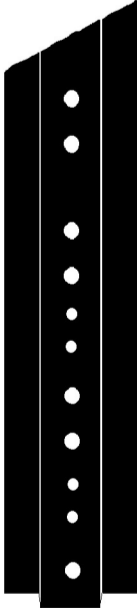
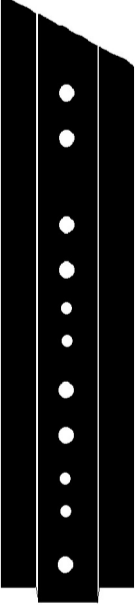
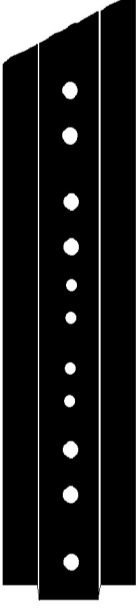
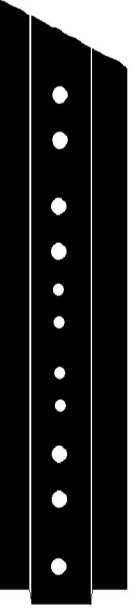
12	12A	13	14	15	16
					
4	4	1	1	1	1

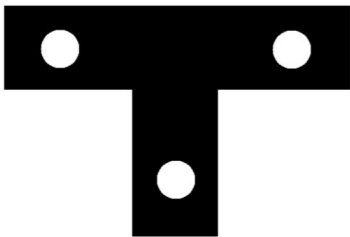
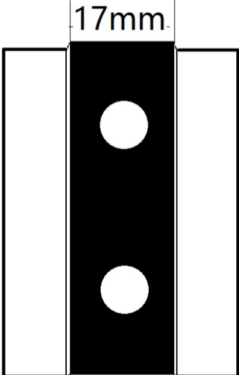
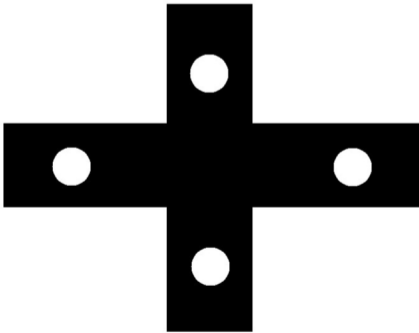

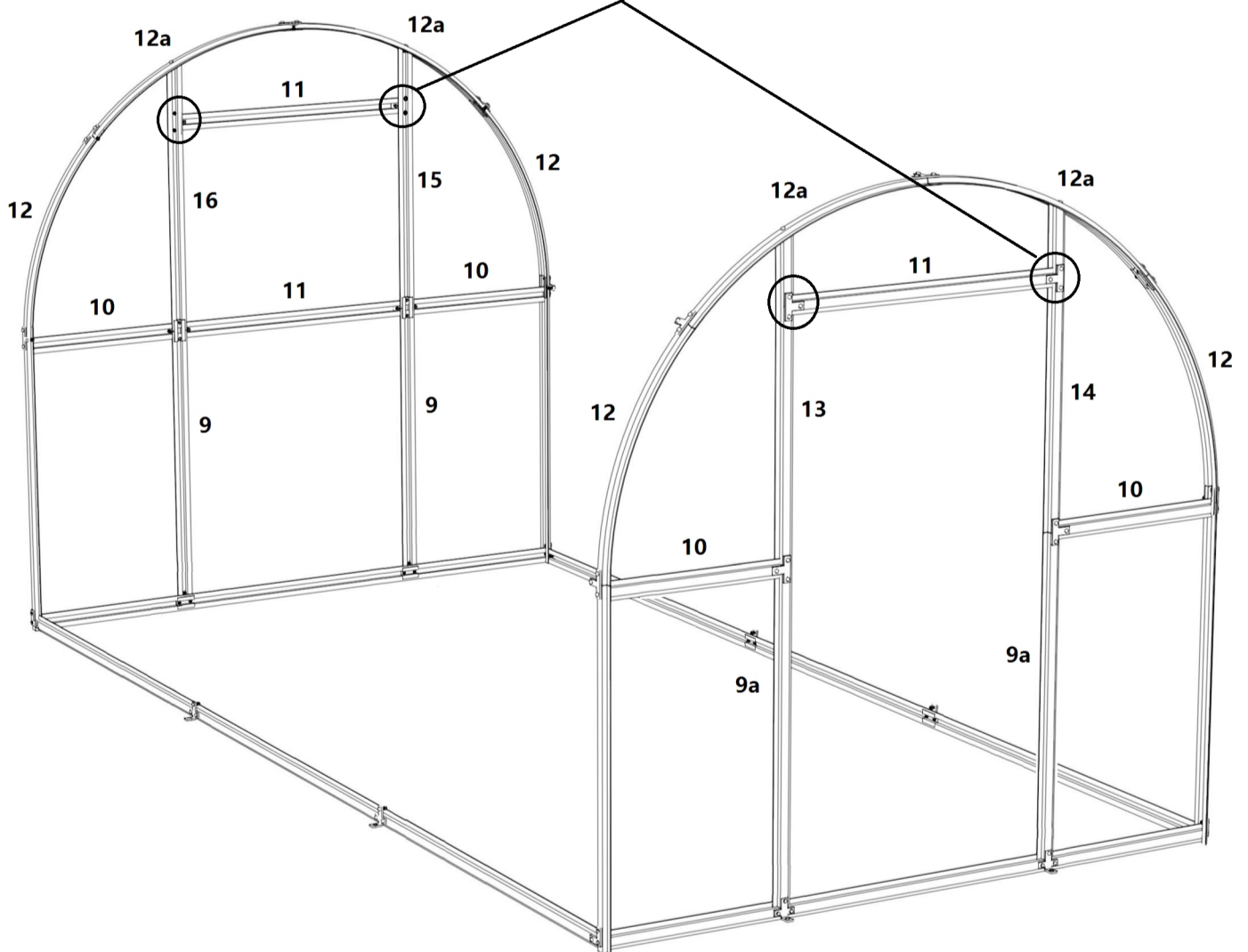
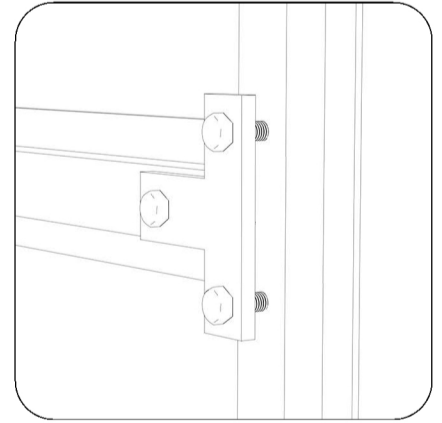
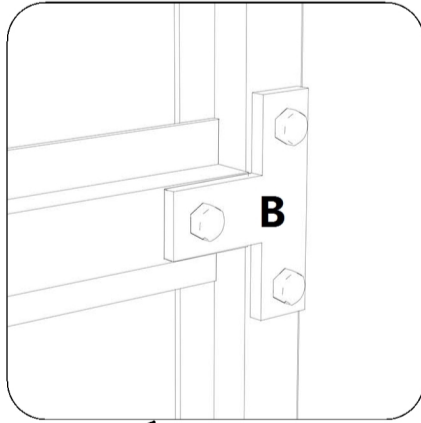
ČÍSLO DÍLU	OBRÁZOK	POČET
B		16
F		14
C		2

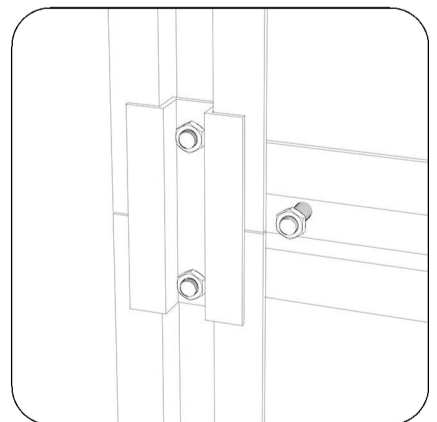
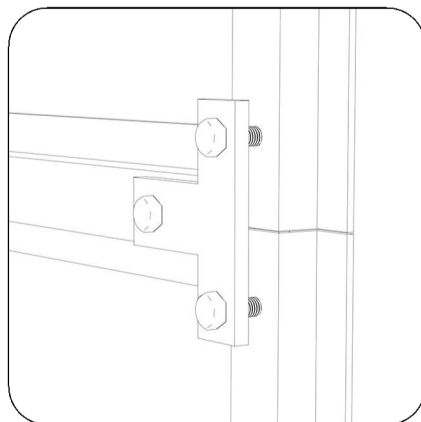
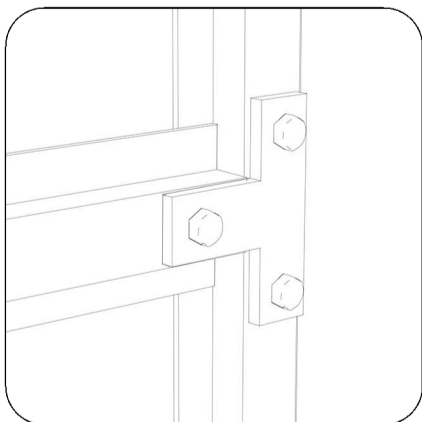
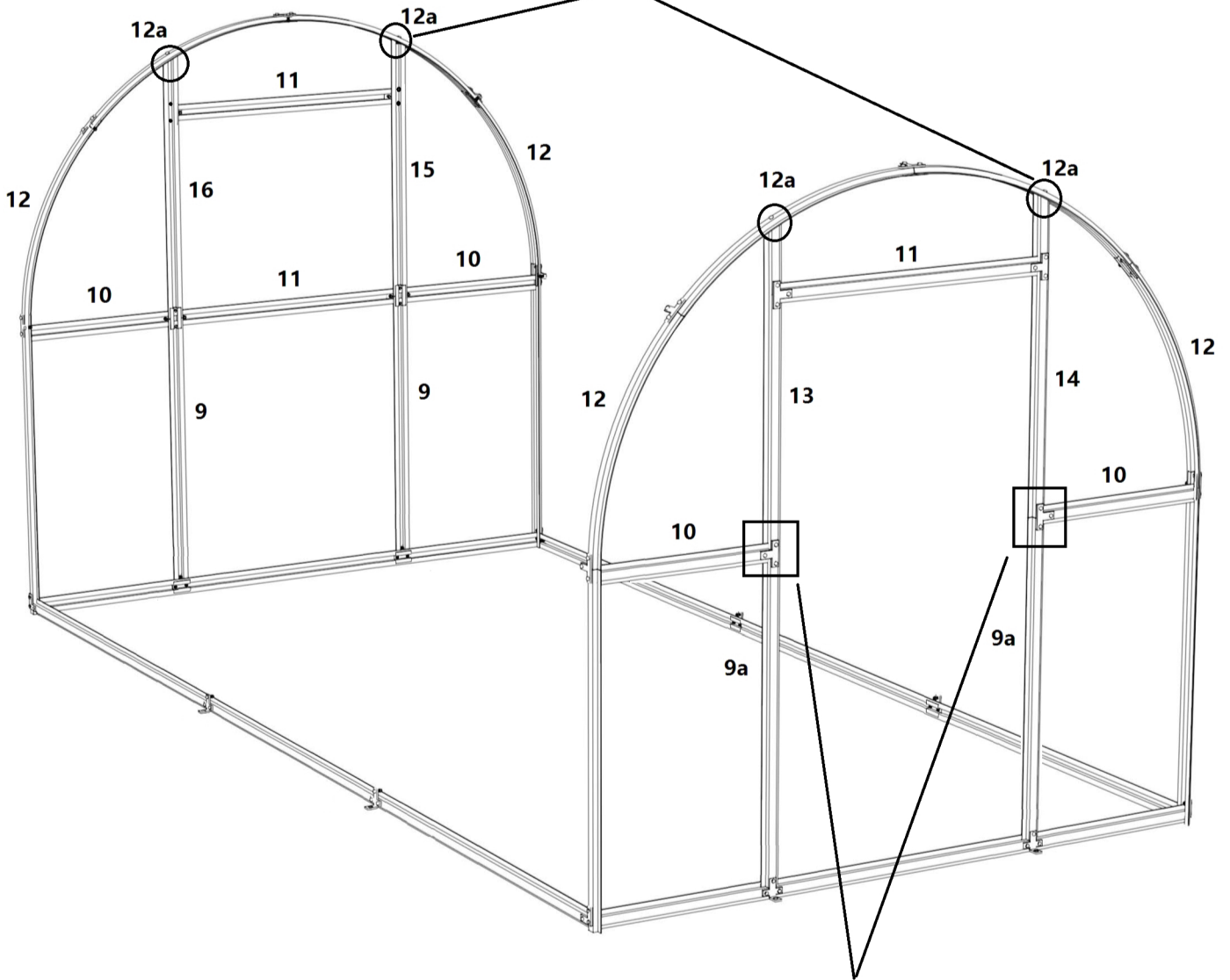
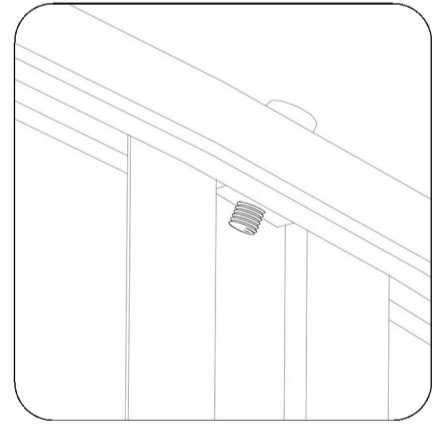
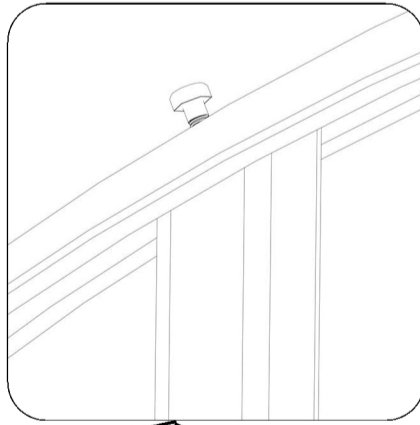

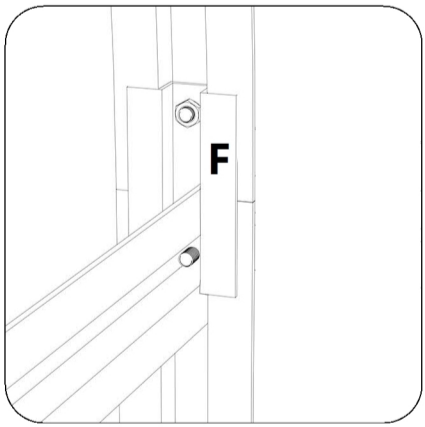
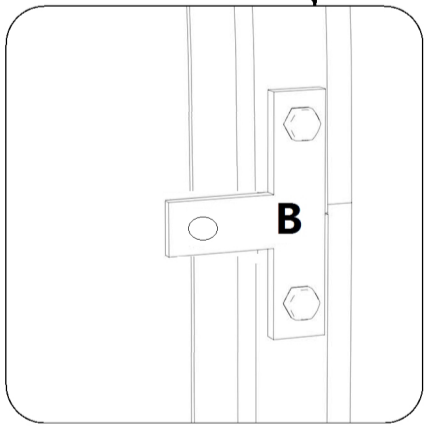
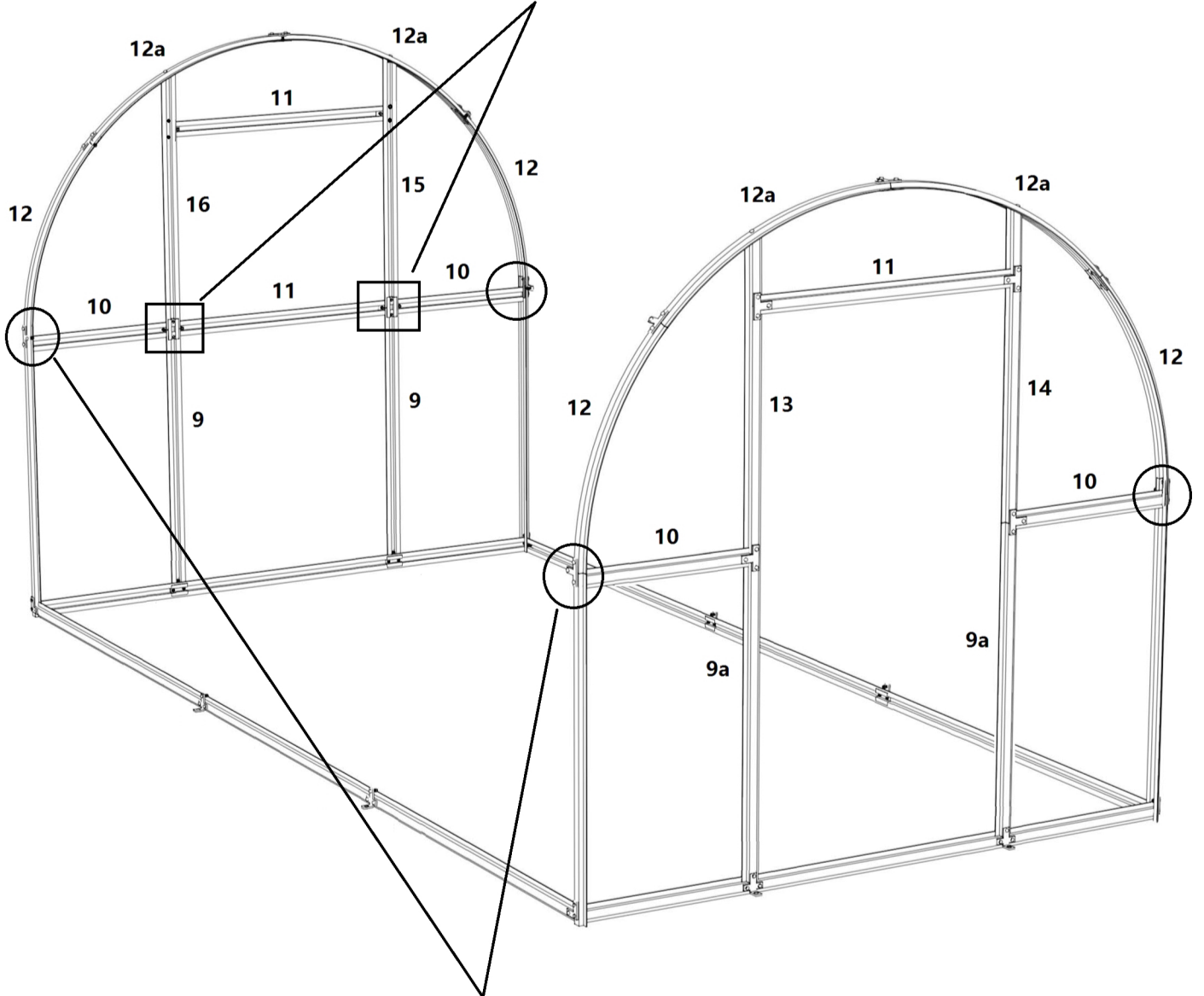
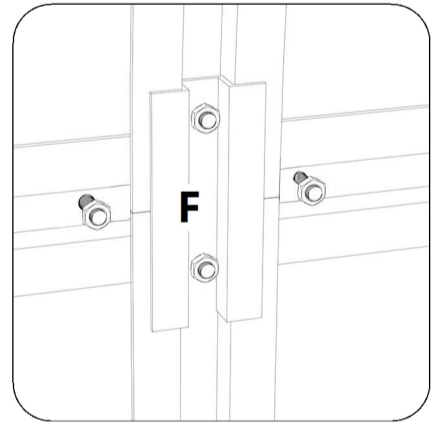
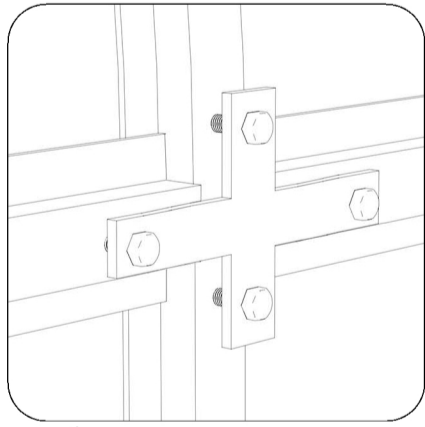
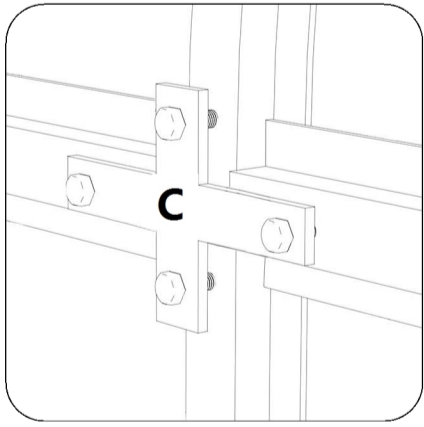



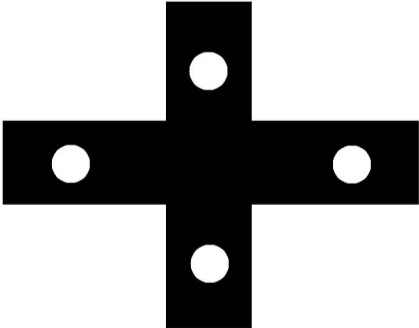
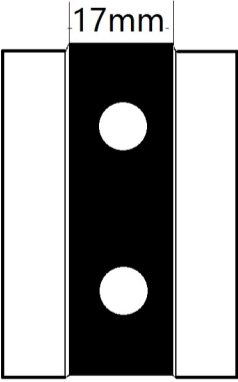

# KROK 3

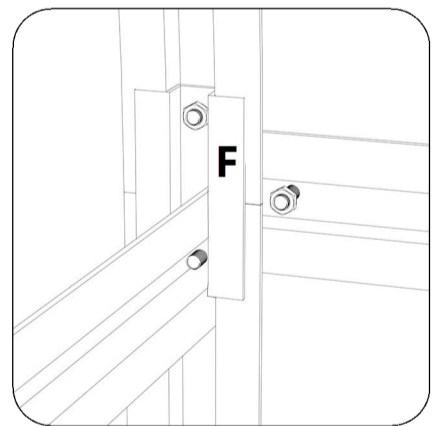
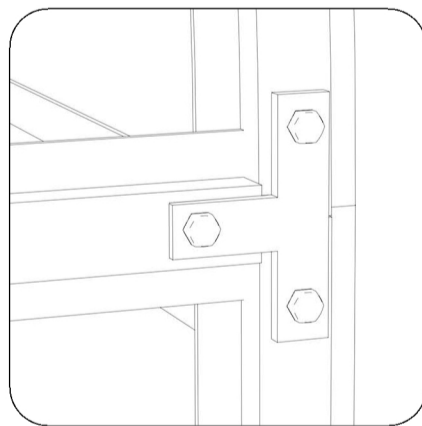
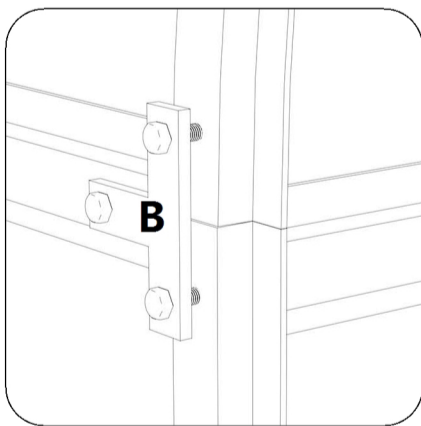
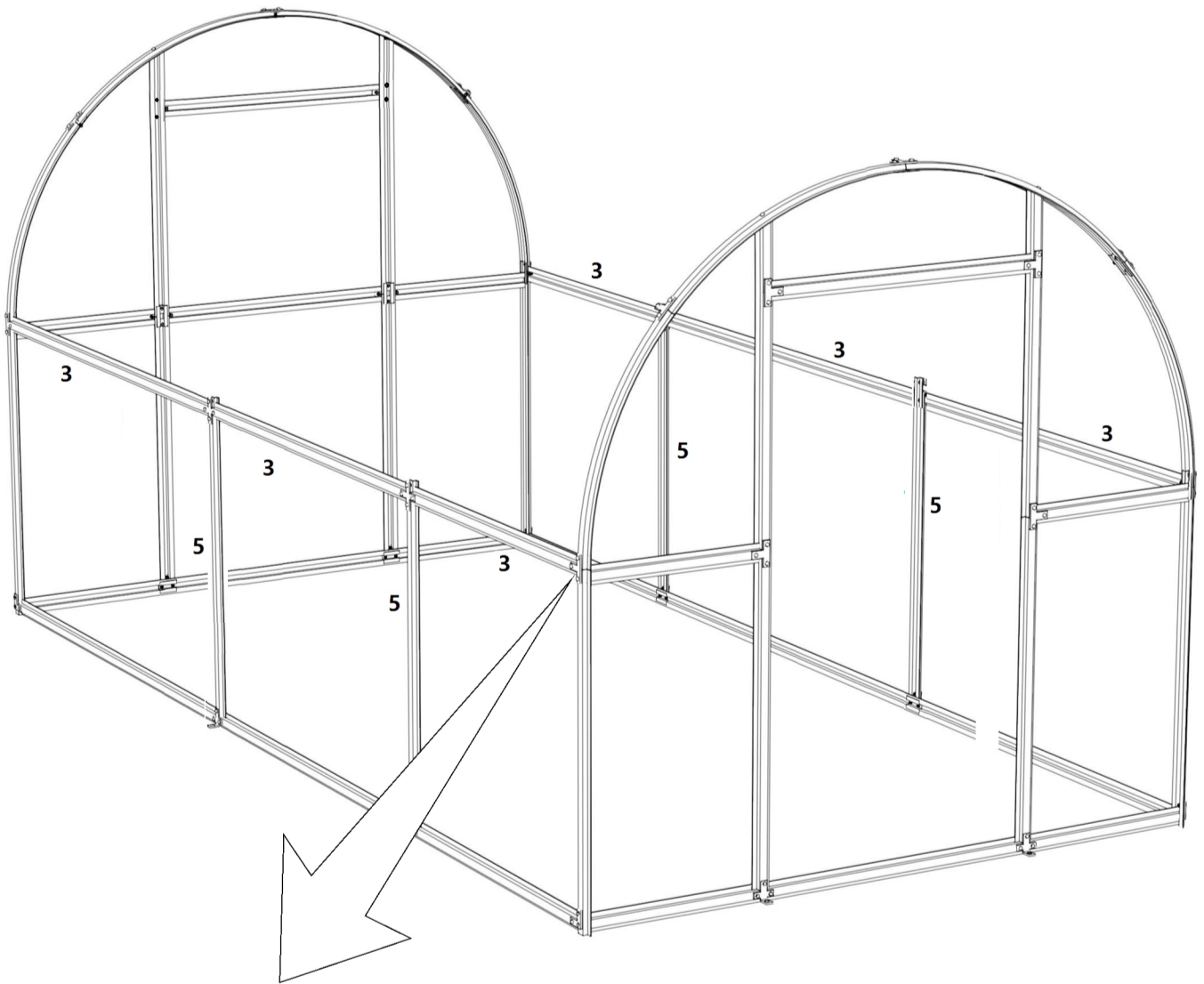
ČÍSLO DÍLU	OBRÁZOK	POČET
3		6
5		4
C		4
F		4

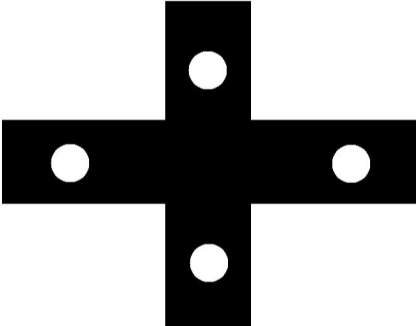
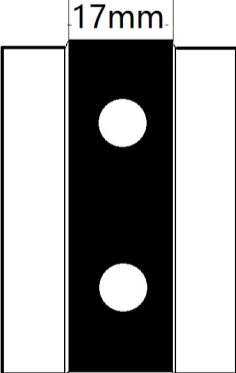

# KROK 4

ČÍSLO DÍLU	OBRÁZOK	POČET
3		9
12		8
C		6
F		6



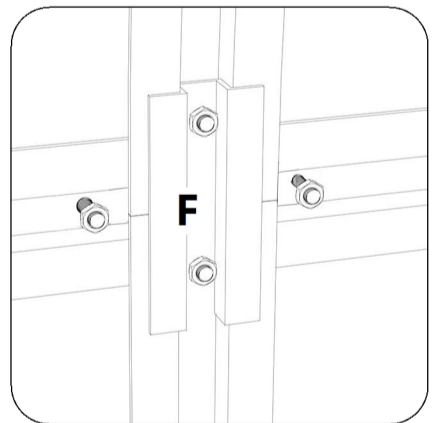
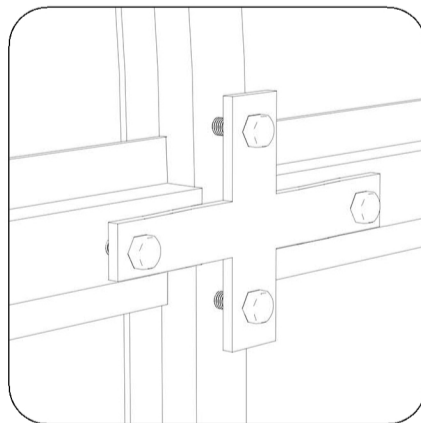
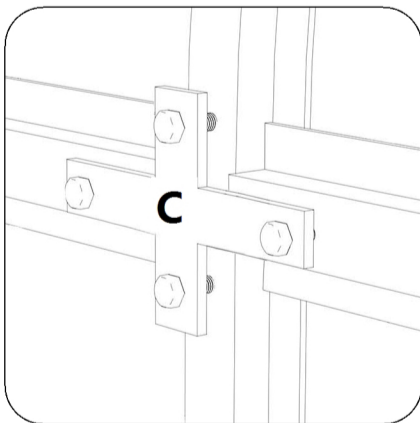
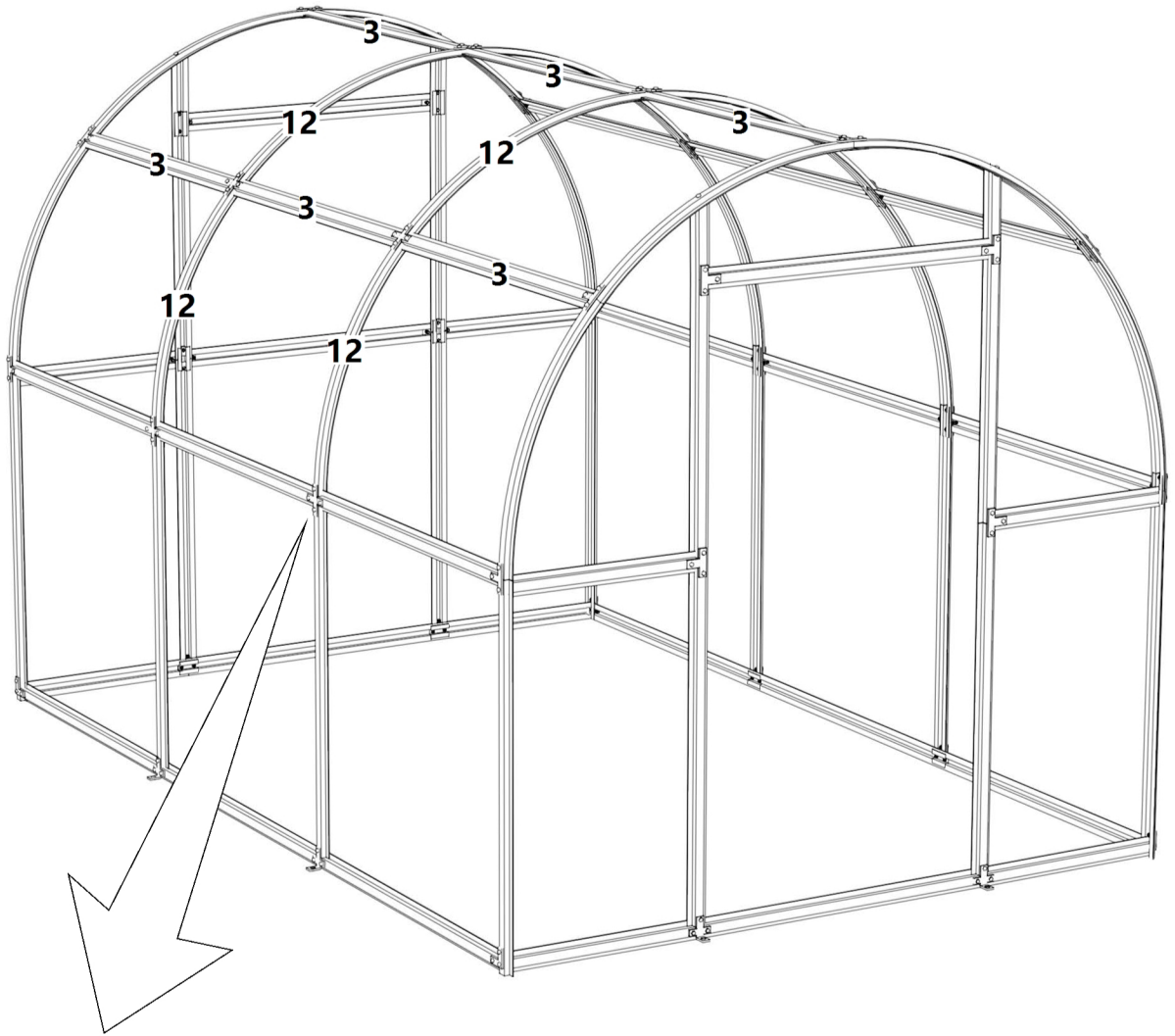

## KROK 5

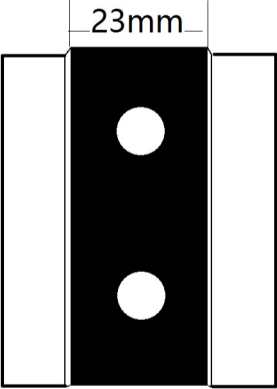
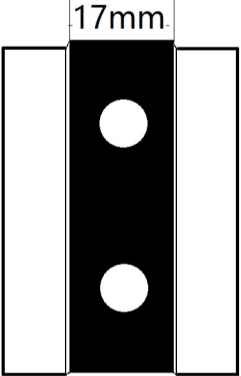
ČÍSLO DÍLU	OBRÁZOK	POČET
E		44
F		30

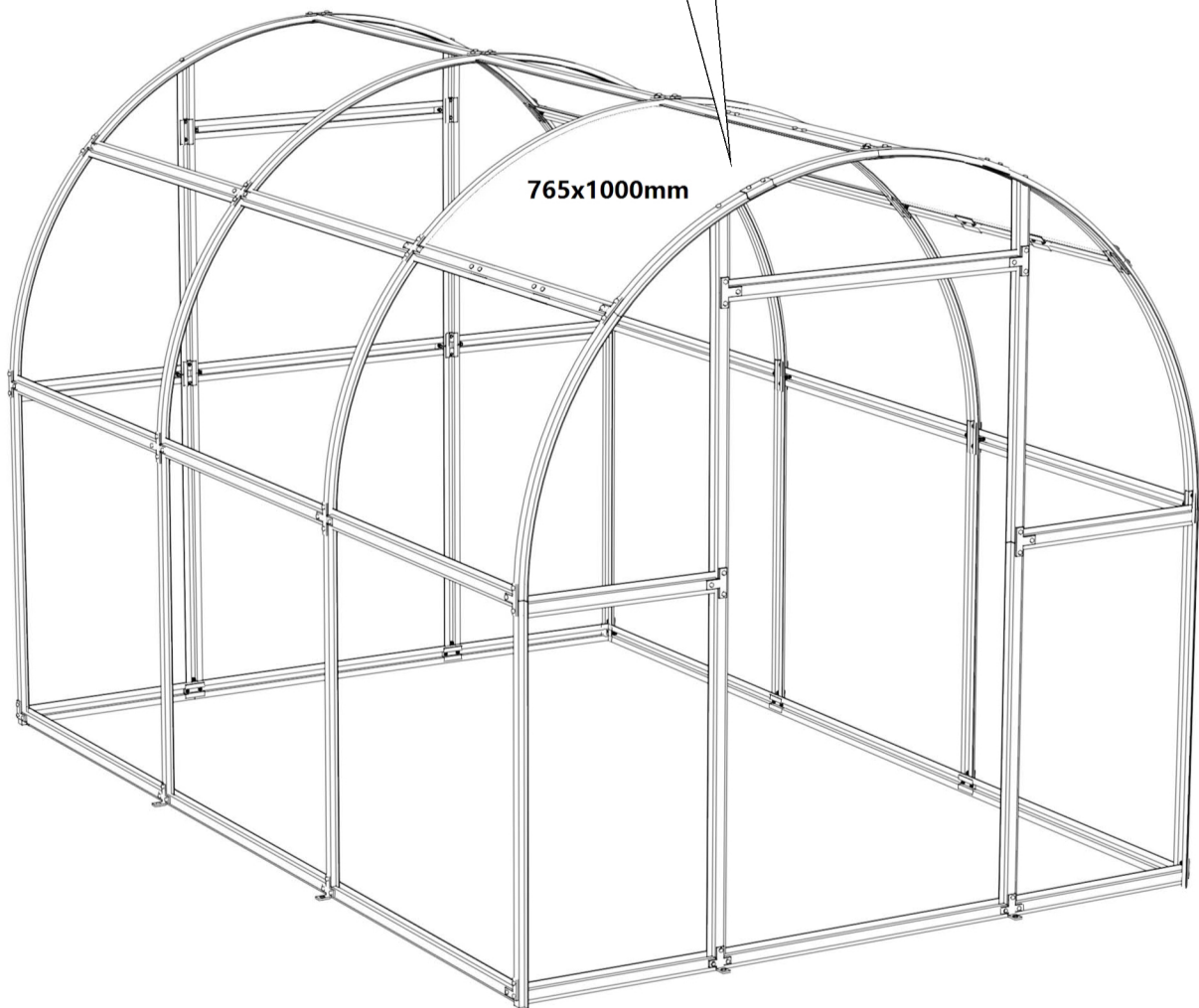
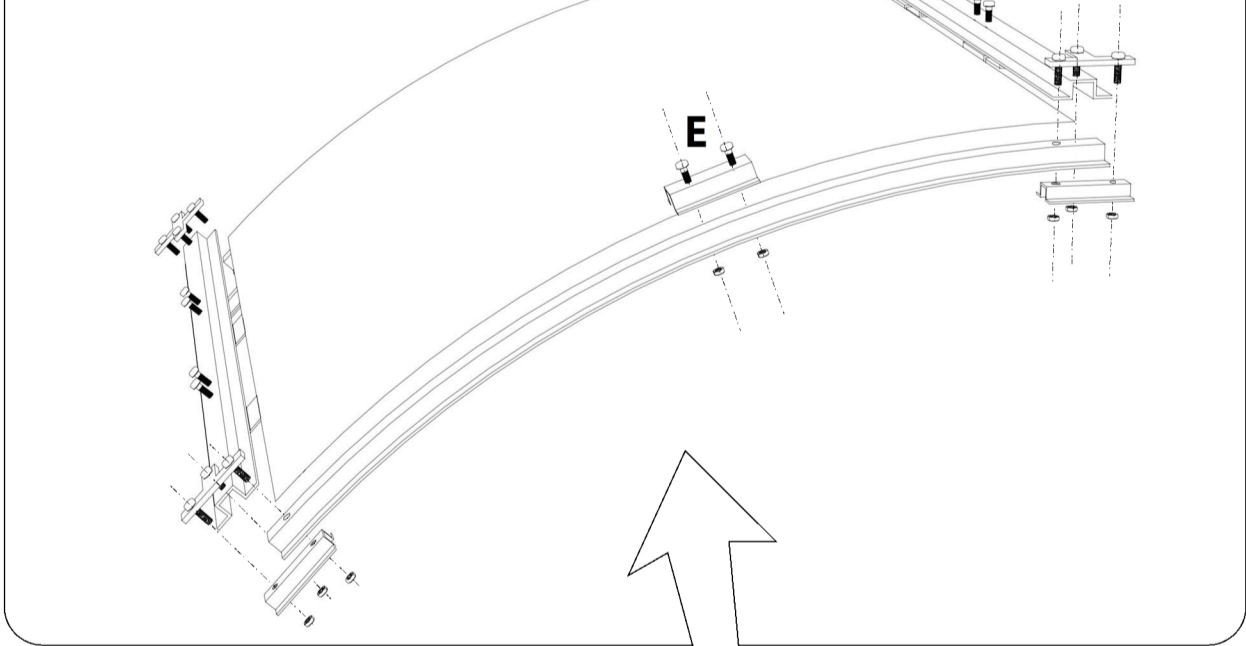

Zatlačte hornú/dolnú časť pod profil 3. Pripevnite spojovací profil F na vnútornú stranu profilu 3, prestrčte skrutky cez profil 3 z vonkajšej strany profilu a spojte ho so spojovacím profilom. Obe strany polykarbonátovej dosky sú pripevnené k hornému okraju profilov 12-12a a upevnené spojovacím profilom E. Polykarbonátové dosky sú rovnakým spôsobom pripevnené k profilom 1 a 2, kde sú tiež pripevnené k profilu a upevnené ku konštrukcii spojovacím profilom E. Po umiestnení všetkých bočných polykarbonátových dosiek do profilov utiahnite skrutky.

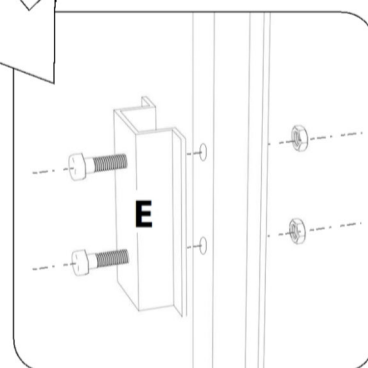
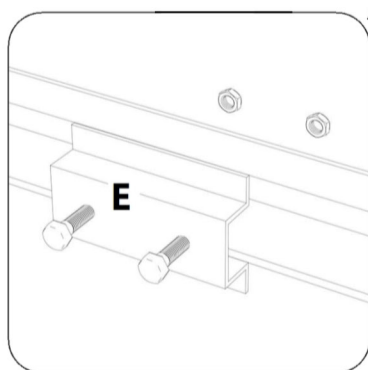
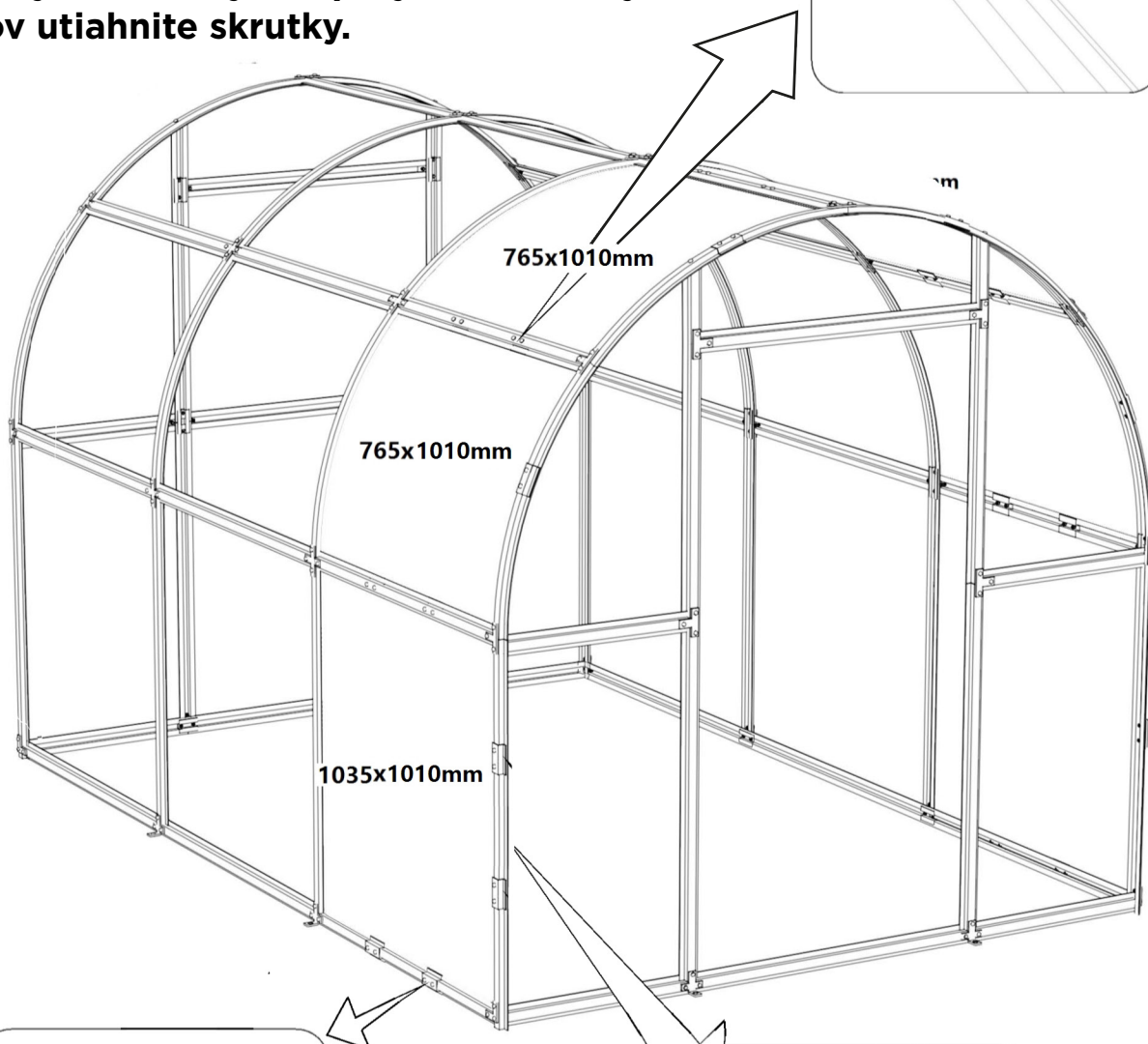
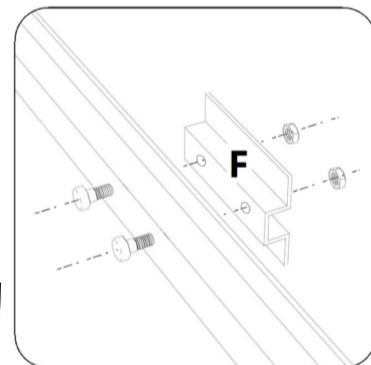

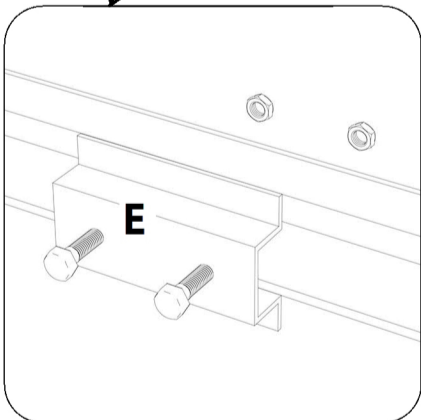
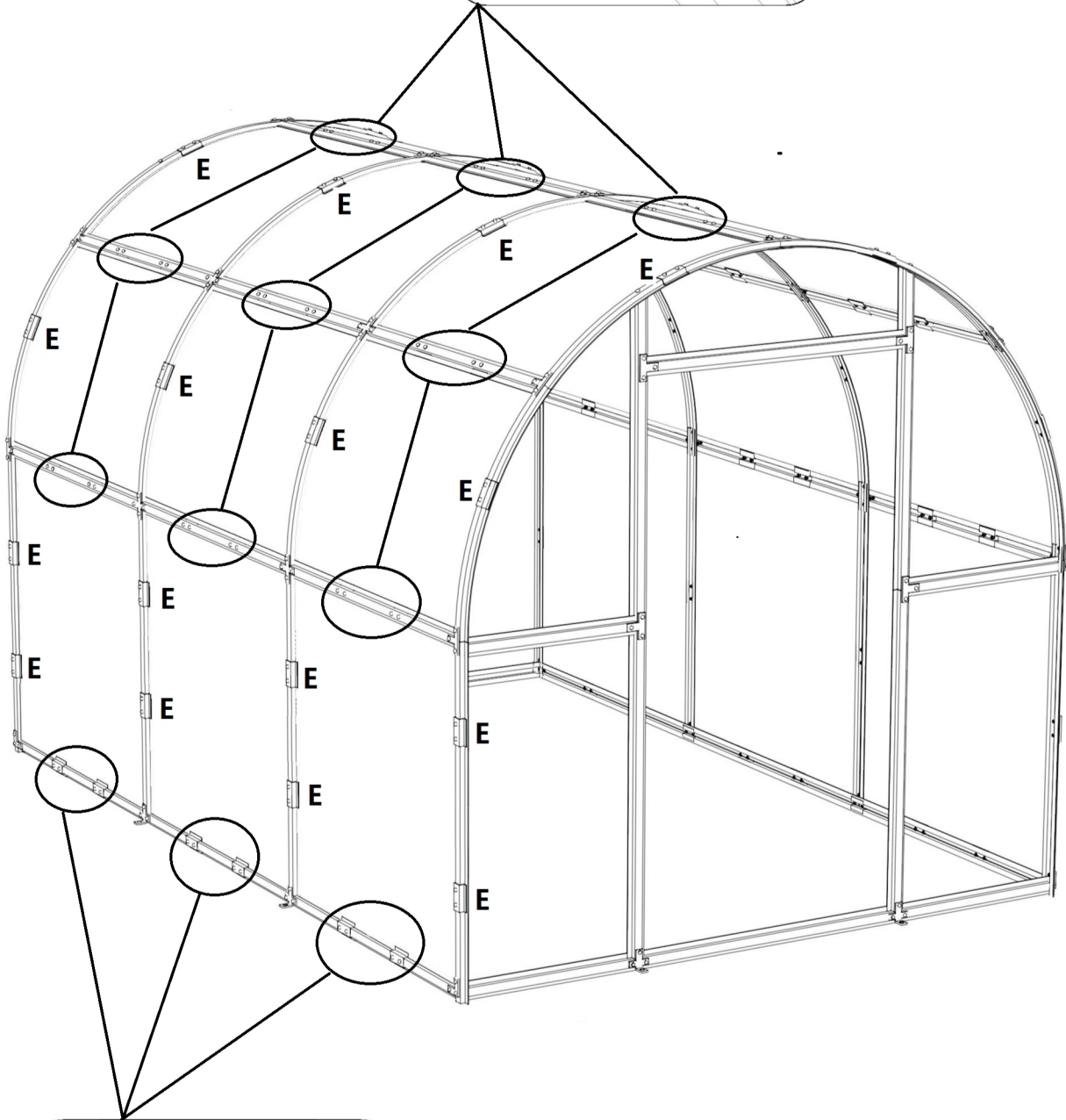
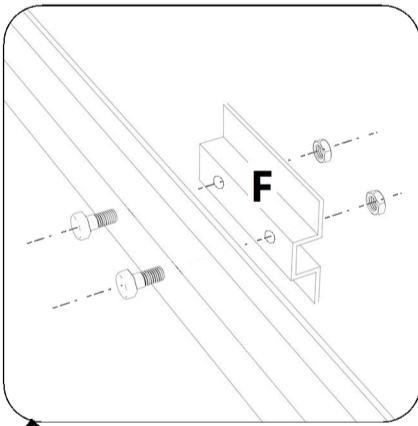

## KROK 6

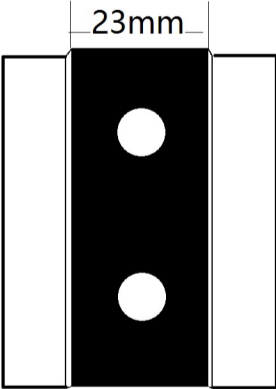
ČÍSLO DÍLU	OBRÁZOK	POČET
E		32

# Predná časť

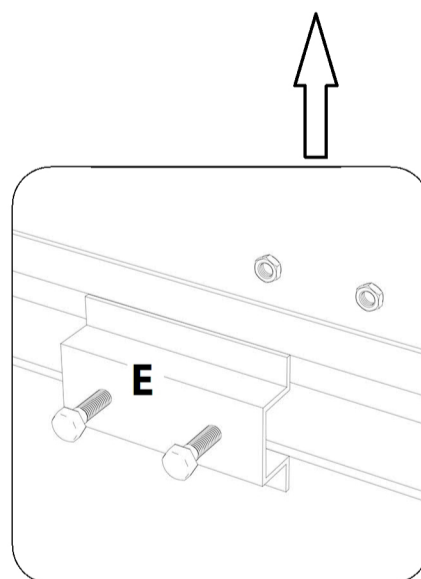
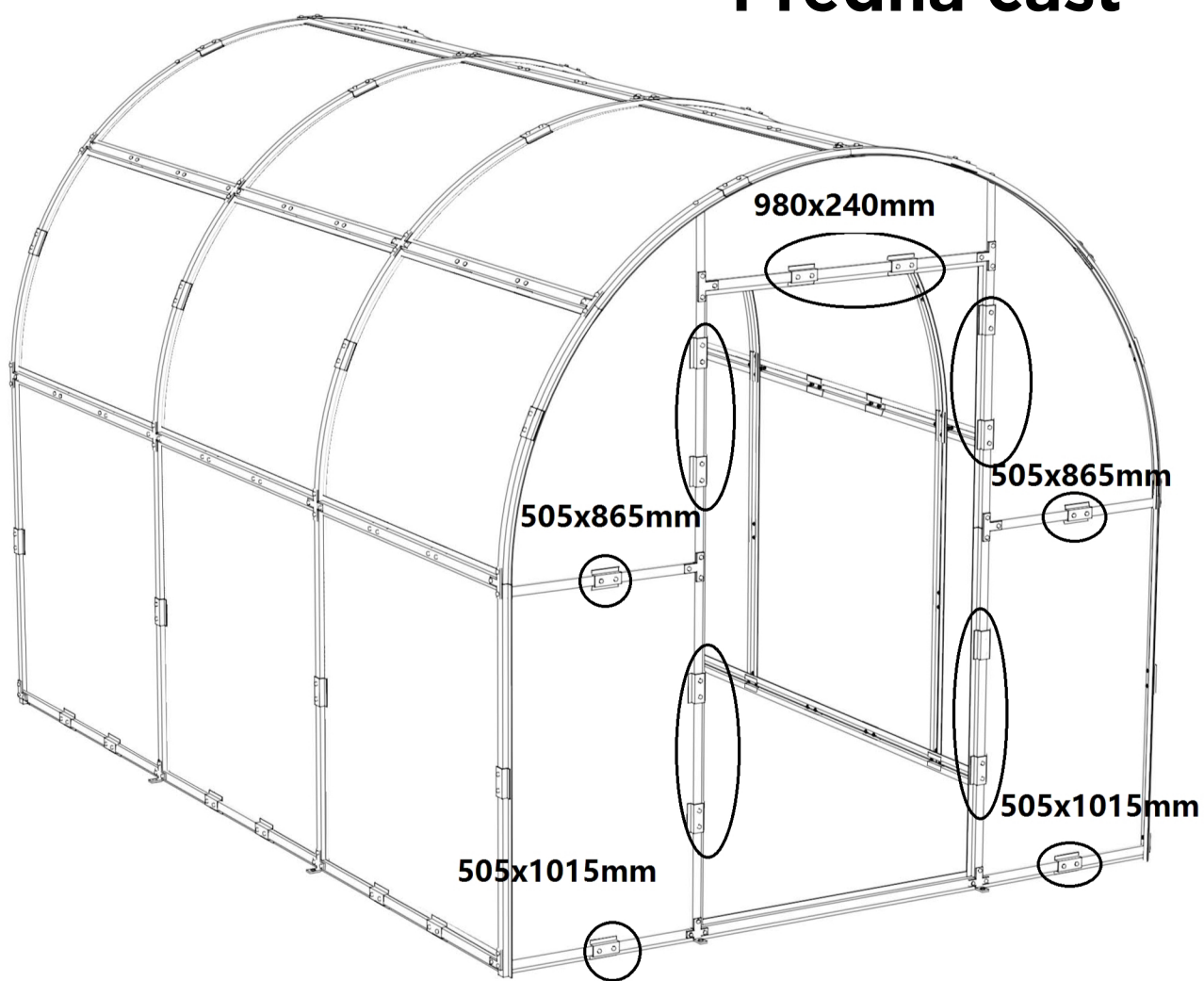



# Zadná část

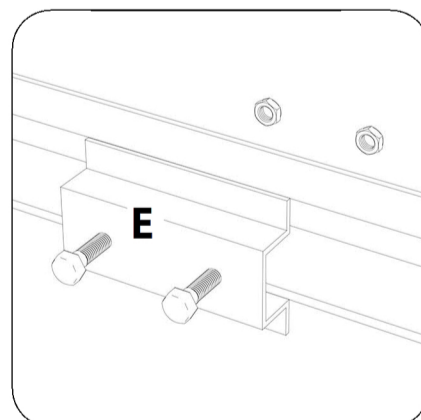
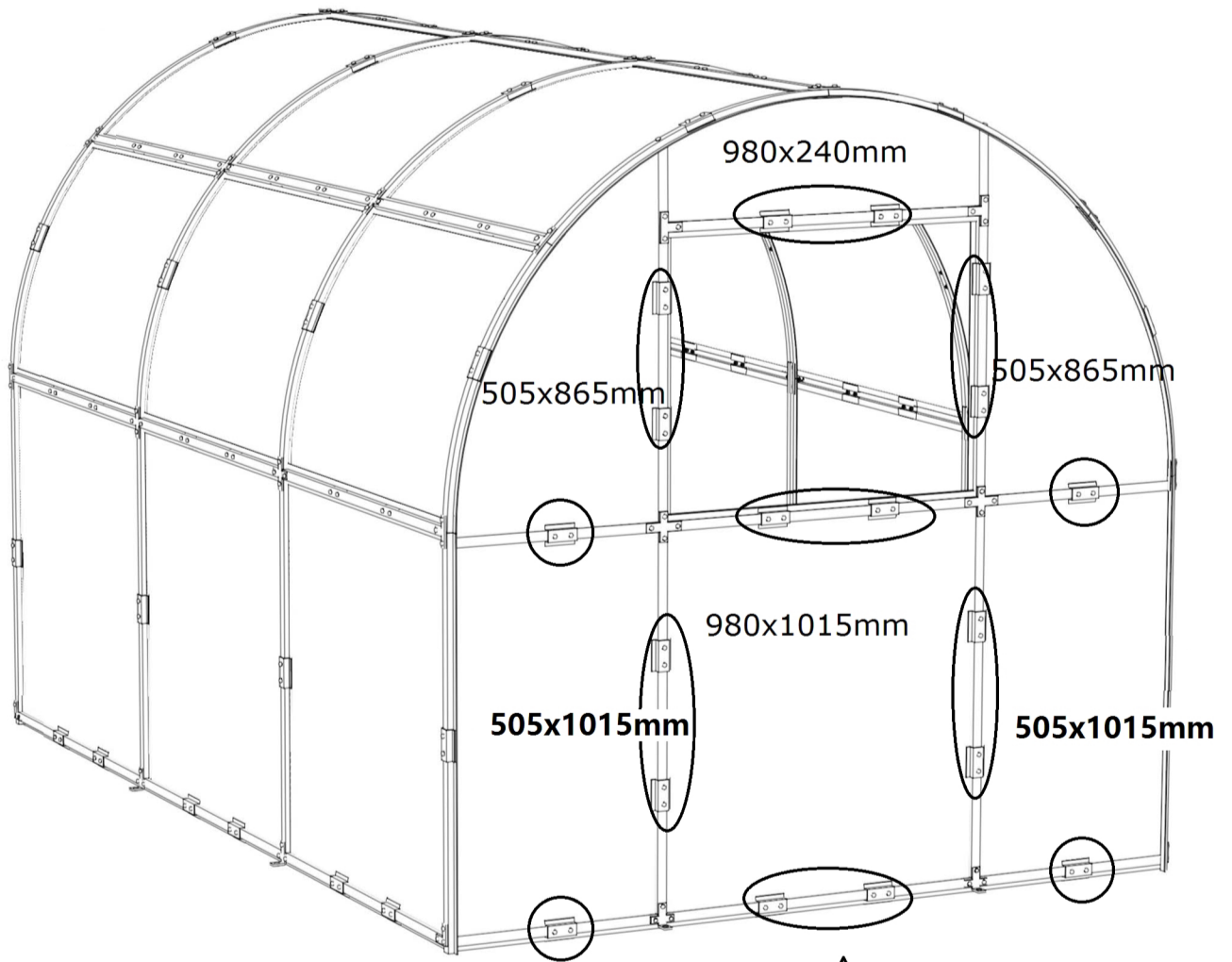

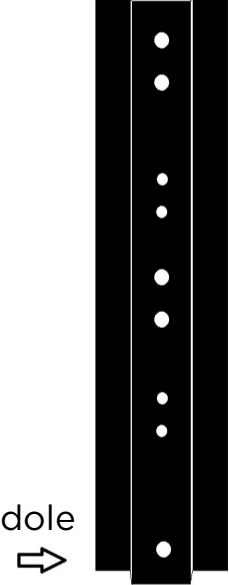
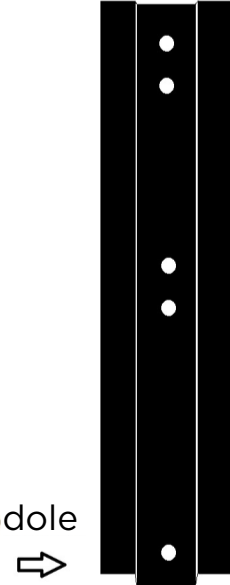
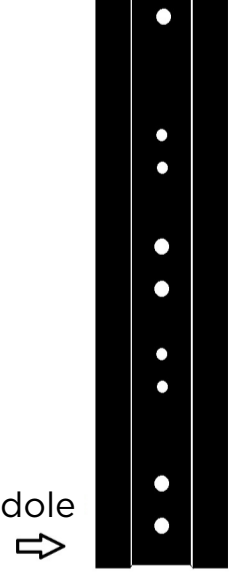

# KROK 7

ČÍSLO DÍLU	17	18	19
OBRÁZOK			
POČET	2	2	2

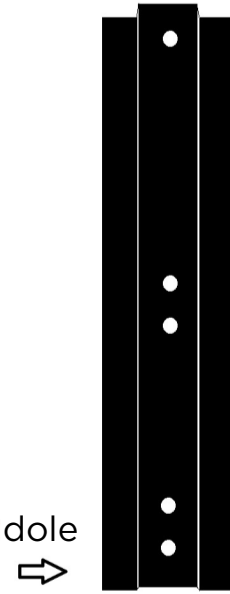
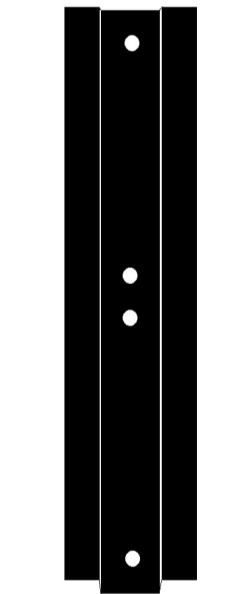
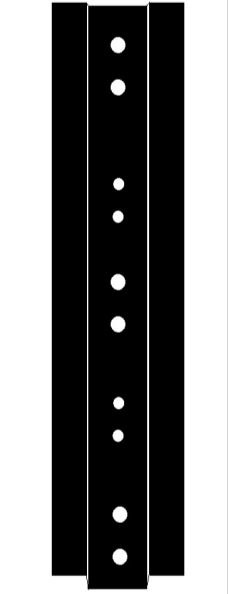
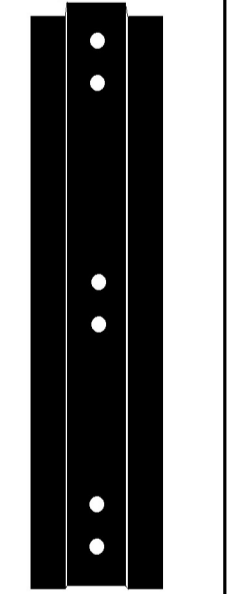
	20	21	22	23
				
	2	10	2	2

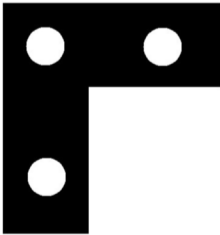
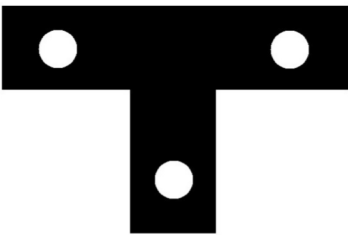
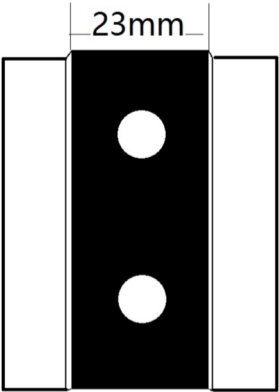
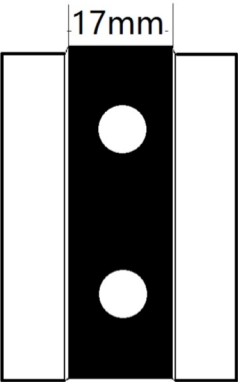
ČÍSLO DÍLU	OBRÁZOK	POČET
A		16
B		4
E		12
F		14

# DVERE

predná strana

zadná strana

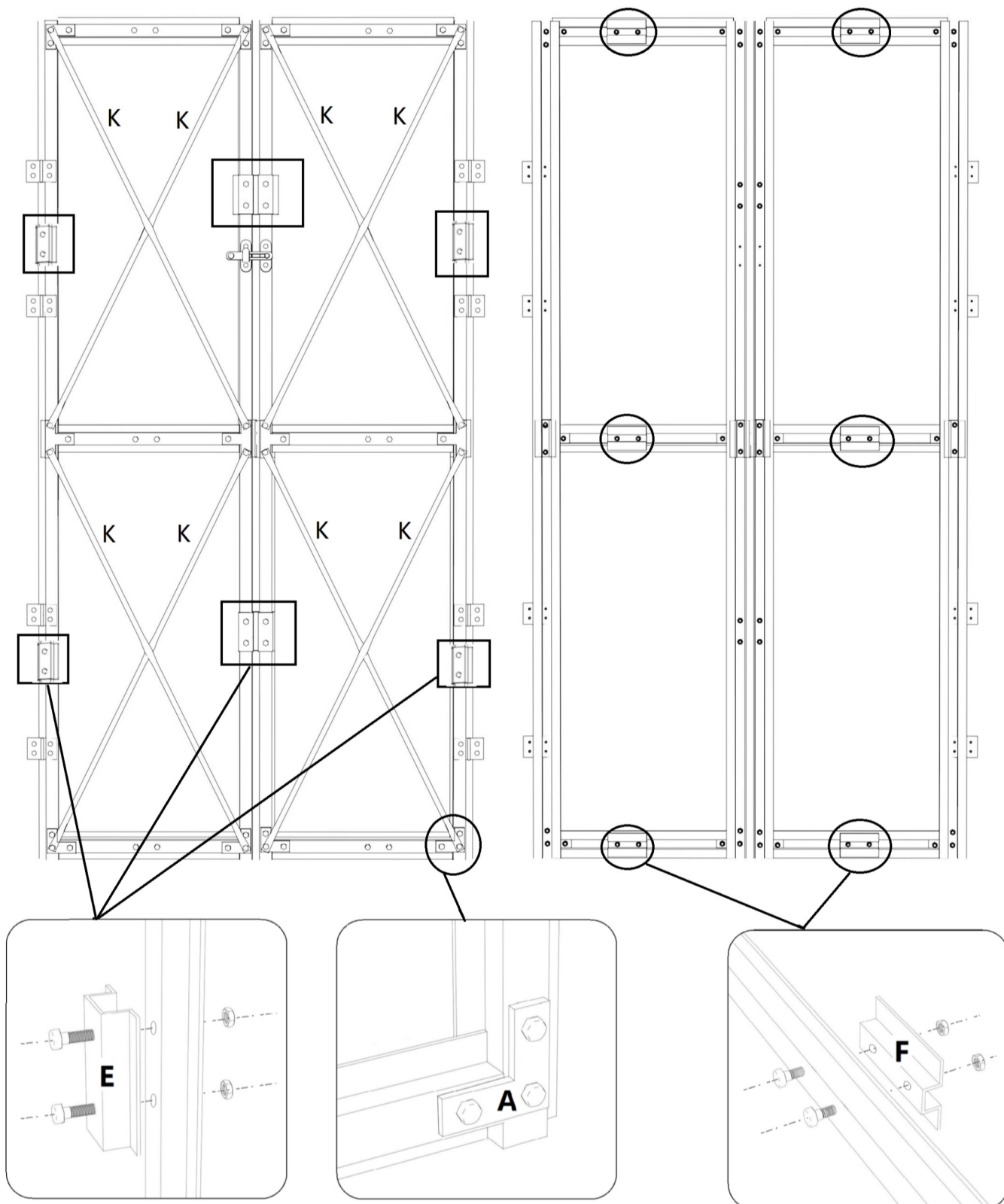

**Hornú a dolnú stranu polykarbonátovej dosky zasuňte pod profil 21, zvnútra pripevnite spojovací profil F a zaistite ho skrutkami. Zvyšné dve strany polykarbonátovej dosky položte na horný okraj profilov 17-20 a zaistite ich spojovacími profilmi E. Potom utiahnite všetky skrutky.**

**Pripevnite pánty a madlá**

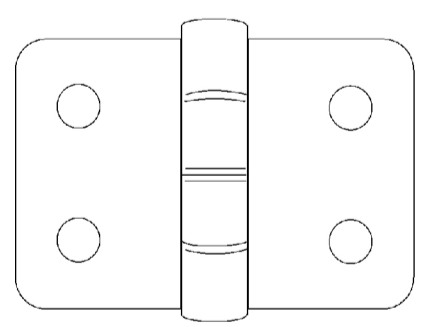
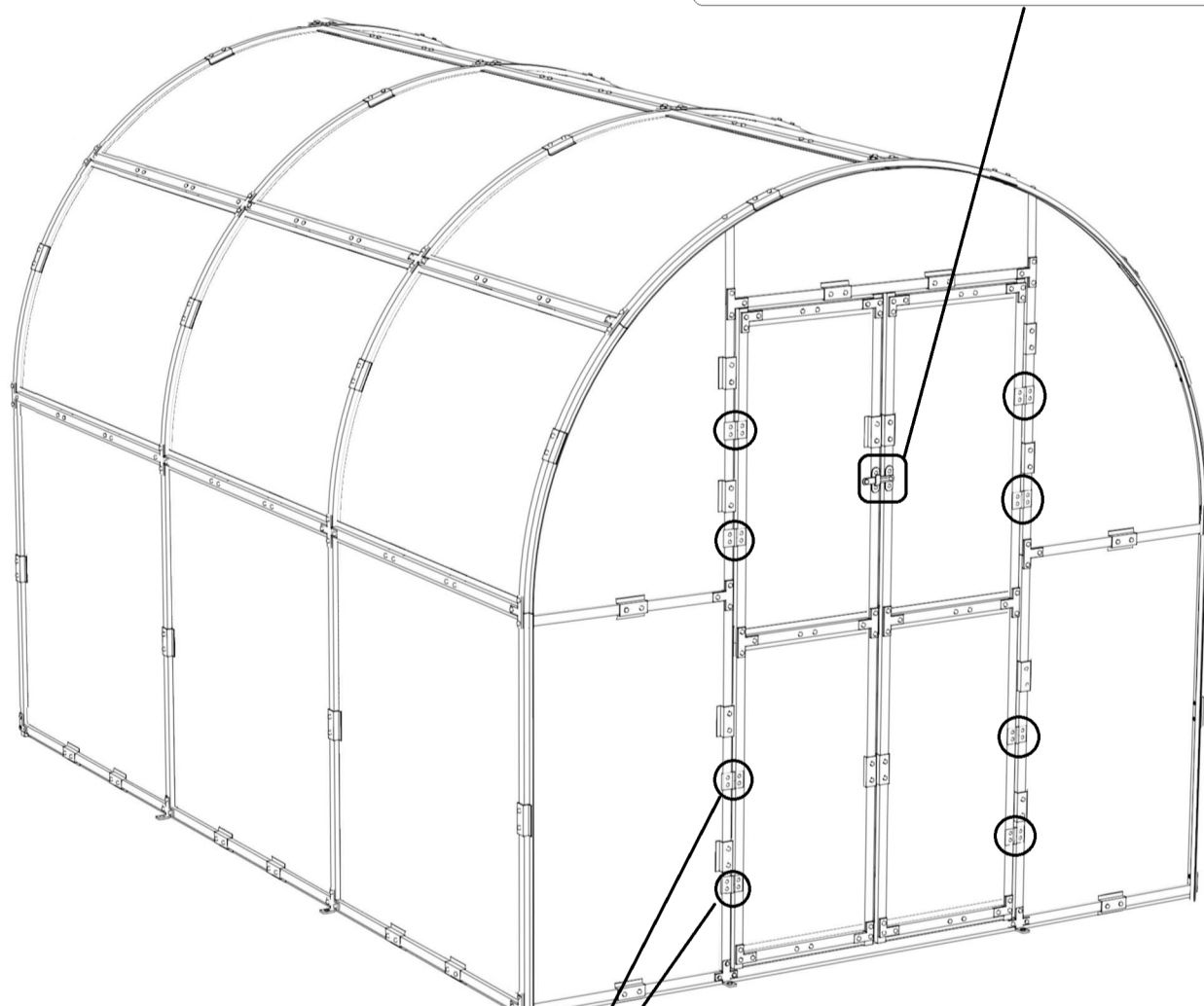
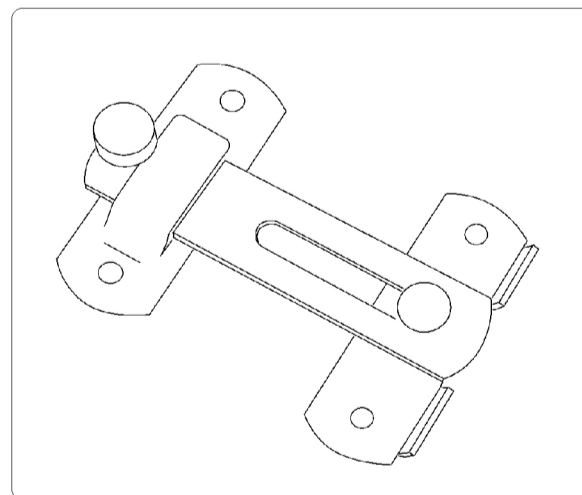

# OKNA

Hornú a dolnú stranu polykarbonátovej dosky zasuňte pod profil 21, zvnútra pripevnite spojovací profil F a zaistíte ho skrutkami. Zvyšné dve strany polykarbonátovej dosky položte na horný okraj profilov 22-23 a zaistíte ich spojovacími profilmi E. Potom utiahnite všetky skrutky.

predná strana

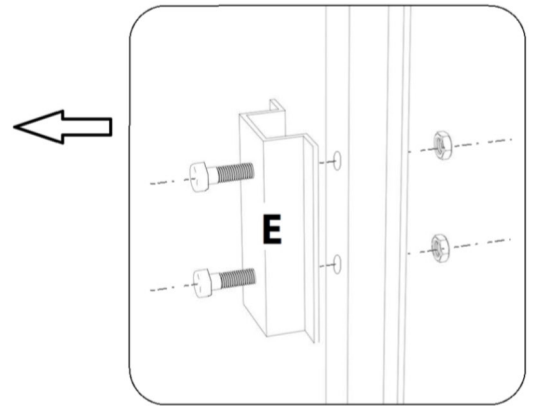
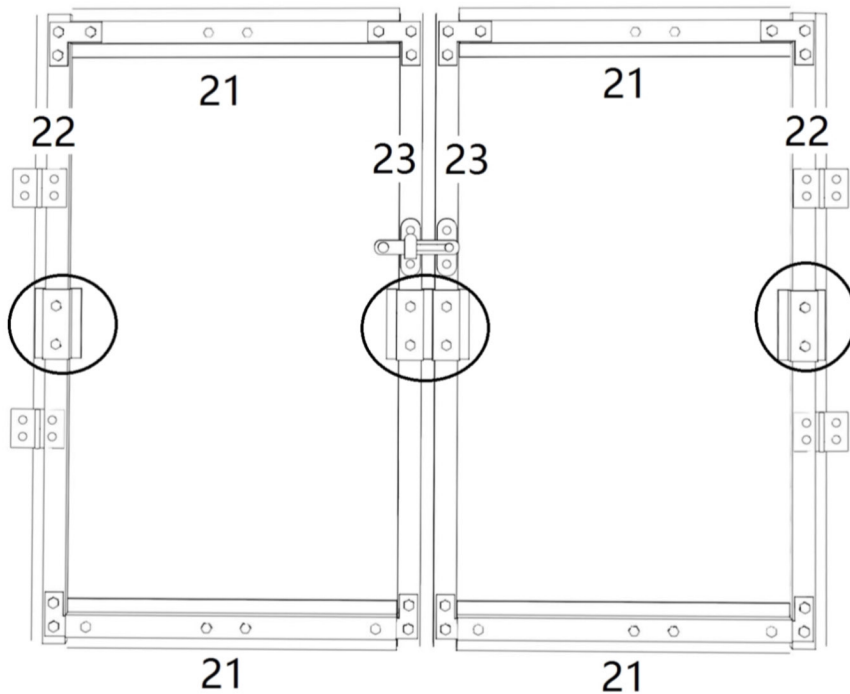

zadná strana

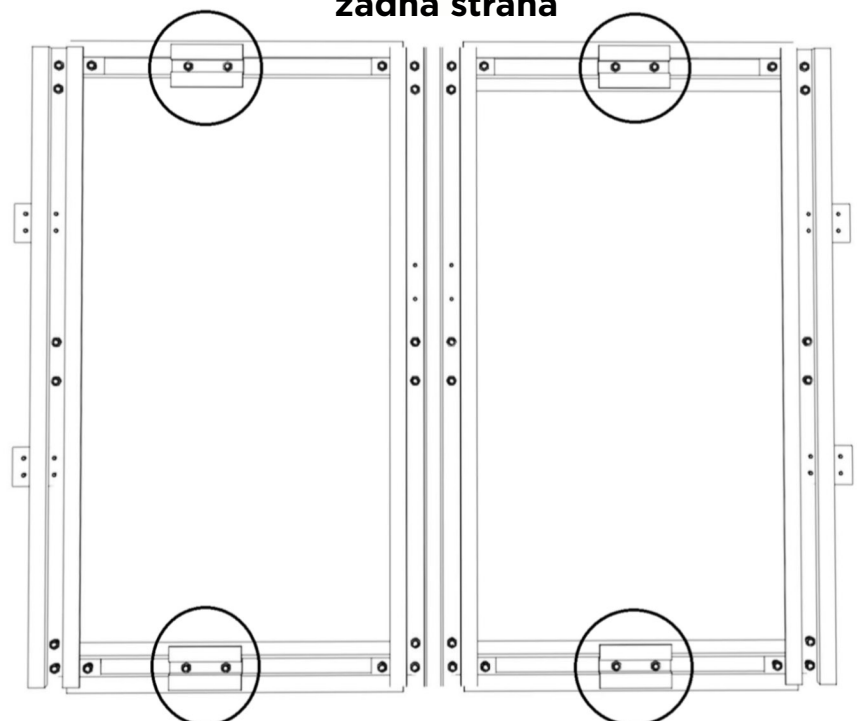
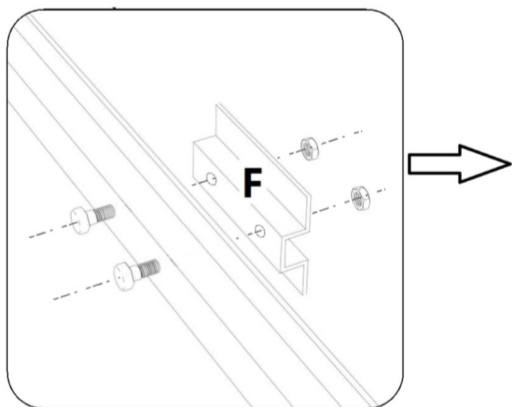

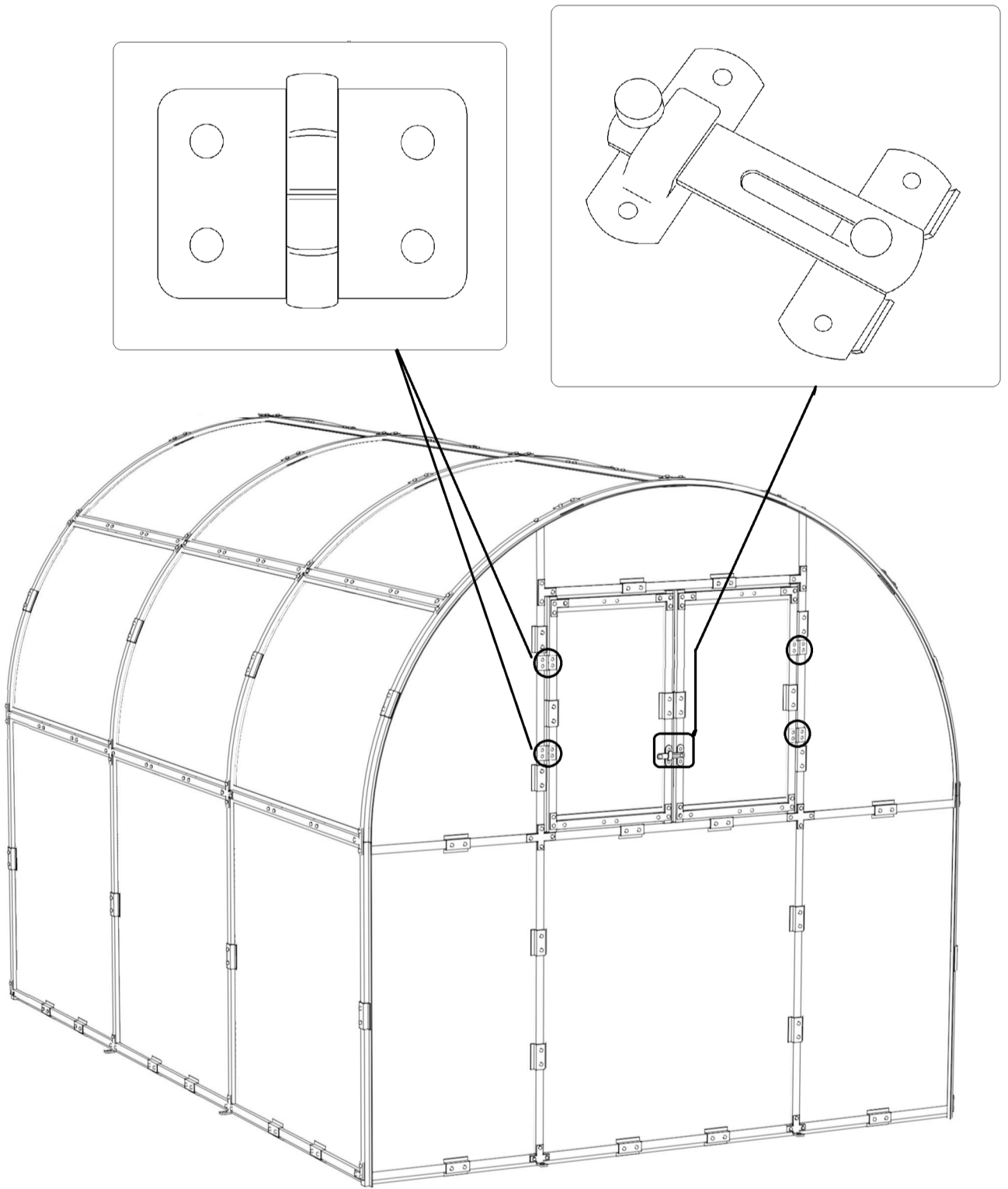

**Pripevnite pánty a madlá**

# OBMEDZOVAČ OTVÁRANIA OKIEN

Ak chcete nainštalovať blokovací hák, vyberte polohu podľa nasledujúceho obrázka. Očko háčika jednoducho prilepte k profilu. Ak si však nie ste istí pevnosťou háčika, môžete ho priskrutkovať k profilu.

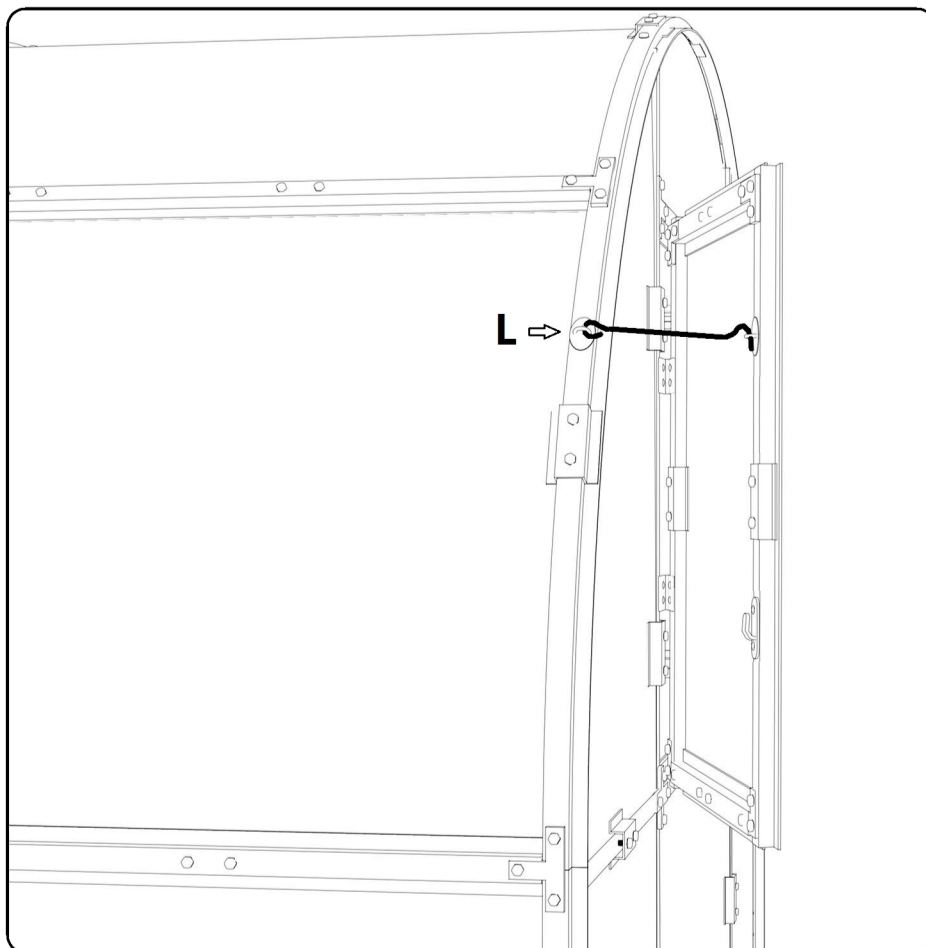

# ■ PROTECO®

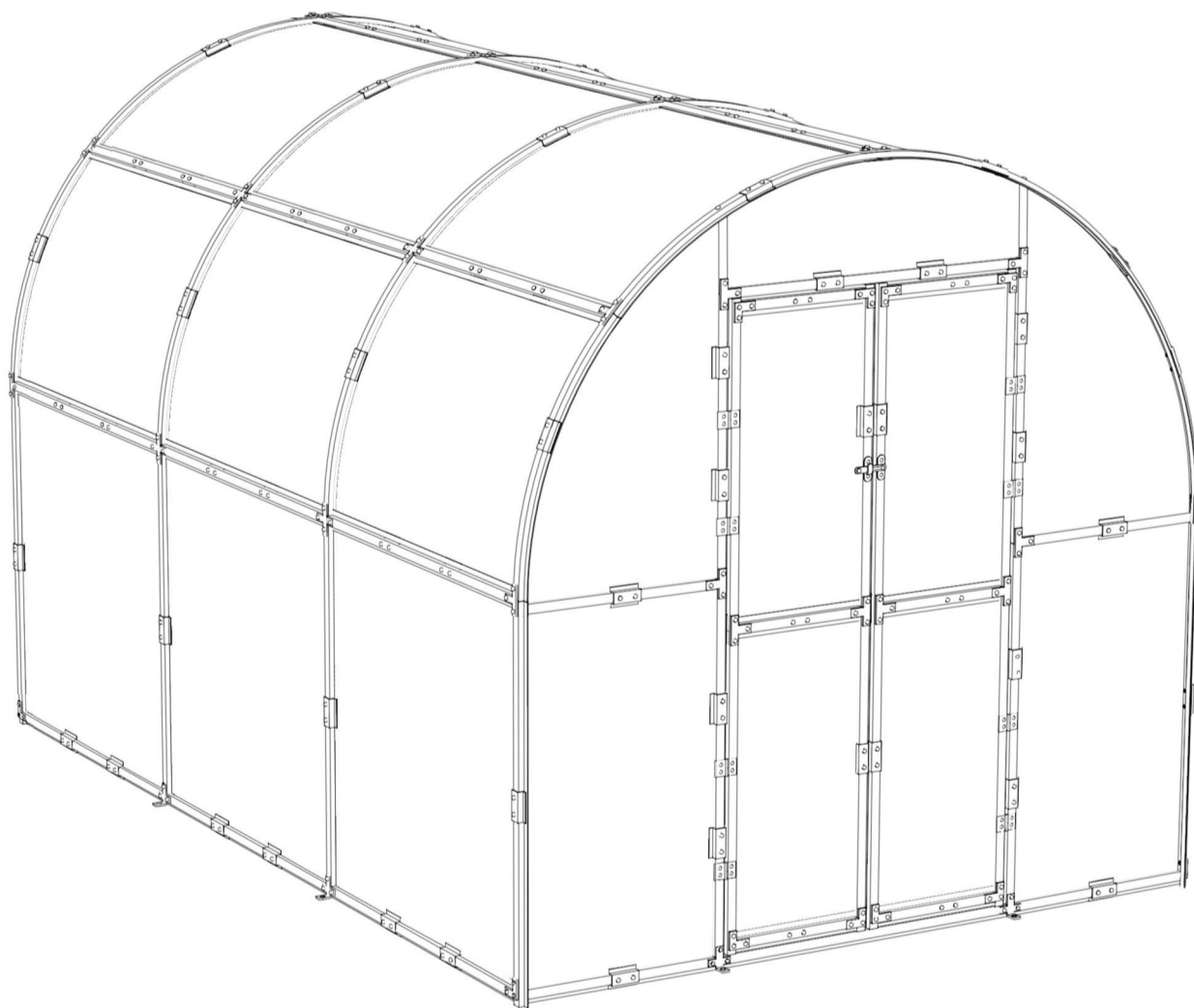

**Dodávateľ pre SK:**  
**PROTECO náradie s.r.o.**  
**Blagoevova 9**  
**Bratislava - Petržalka 851 04**  
**[www.proteco-naradie.sk](http://www.proteco-naradie.sk)**